

PE-5000 USER

4/2-channel Intel® XL710/X550-AT2 10G PoE+ LAN,
IEEE 802.3at Compliant PCI Express x8/x4 Expansion Card

Manual

Record of Revision

Version	Date	Page	Description	Remark
0.10	2020/02/13	All	Preliminary Release	
1.00	2020/02/15	All	Official Release	
1.10	2023/06/21	6	Update	

Disclaimer

This manual is released by Vecow Co., Ltd. for reference purpose only. All product offerings and specifications are subject to change without prior notice. Vecow Co., Ltd. is under no legal commitment to the details of this document. Vecow shall not be liable for direct, indirect, special, incidental, or consequential damages arising out of the use of this document, the products, or any third party infringements, which may result from such use.

Declaration of Conformity

FCC This equipment has been tested and found to comply with the limits for a Class A digital device, pursuant to part 15 of the FCC Rules. These limits are designed to provide reasonable protection against harmful interference when the equipment is operated in a commercial environment. This equipment generates, uses, and can radiate radio frequency energy, and if it is not installed and used in accordance with the instruction manual, it may cause harmful interference to radio communications. Operation of this equipment in a residential area is likely to cause harmful interference in which case the user will be required to correct the interference at his own expense.

CE The products described in this manual comply with all applicable European Union (CE) directives if it has a CE marking. For computer systems to remain CE compliant, only CE-compliant parts may be used. Maintaining CE compliance also requires proper cable and cabling techniques.

Copyright and Trademarks

This document contains proprietary information protected by copyright. No part of this publication may be reproduced in any form or by any means, electric, photocopying, recording or otherwise, without prior written authorization by Vecow Co., Ltd. The rights of all the brand names, product names, and trademarks belong to their respective owners.

Order Information

Part Number	Description
PE-5004	Intel® XL710 8-CH PCI Express Card with 10GigE PoE+
PE-5002	Intel® X550-AT2 4-CH PCI Express Card with 10GigE PoE+

Table of Contents

CHAPTER 1	GENERAL INTRODUCTION	vi
	1.1 Overview	vi
	1.2 Features	1
	1.3 Product Specification	2
	1.3.1 Specifications of Vecow PE-5004	2
	1.3.2 Specifications of Vecow PE-5002	3
	1.4 Mechanical Dimension	4
	1.4.1 PE-5004	4
	1.4.2 PE-5004 With FAN	4
	1.4.3 PE-5002	5
	1.4.4 PE-5002 With FAN	5
CHAPTER 2	GETTING TO KNOW YOUR PE-5000	6
	2.1 Packing List	6
	2.2 PE-5004 I/O and Indication	7
	2.3 PE-5002 I/O and Indication	11
CHAPTER 3	GETTING START	15
	3.1 Installing PE-5004/PE-5002	15
CHAPTER 4	DRIVER INSTALLATION AND SETTING	17
	4.1 Driver Installation	17
	4.2 Jumbo Frame	25
	4.3 Link Aggregation	29
APPENDIX A	: PoE Guide	34
APPENDIX B	: Software Functions	38

1

GENERAL INTRODUCTION

1.1 Overview

PE-5000 is a series of 10GigE PoE⁺ PCIe Expansion Card, supporting IEEE 802.3at PoE⁺ up to 25.5W power output at 48V DC per port. Powered by Intel[®] XL710/Intel[®] X550-AT2, PE-5000 provides 4-port/2-port Independent 10GigE Ethernet and performance enhanced LAN features, IEEE 802.3az Energy Efficient Ethernet (EEE) and DMA Coalescing (DMAC) Power Management functions. Just simply by RJ45 or optional rugged M12 connections, Vecow PE-5000 is enabled to provide up to 10Gbps data rate each port with teaming functions, link aggregation (LAG), up to 15.5K Jumbo Frame, IEEE 1588 Precision Time Protocol (PTP), IEEE 802.3AS and easy maintenance.

Featuring PCI Express x8/x4 interface, PE-5000 supports data transfer rate up to 8.0 GT/s with PCIe 3.0. With broad deployment of 10GigE in machine vision applications, Vecow PE-5000 delivers high-speed, simplified and flexible benefits for industrial applications in Scientific Research, Goal-line Technology, AI Surveillance, real-time inspection, and any Industry 4.0/IIoT applications.

1.2 Features

- Intel® XL710 10GBASE-T Ethernet Controller and Intel® X557 PHY supports 4-port independent 10GigE PoE⁺ LAN, up to 10Gbps data rate (PE-5004)
- Intel® X550-AT2 10GBASE-T Ethernet Controller supports 2-port independent 10GigE LAN, up to 10Gbps data rate (PE-5002)
- PCI Express x8 interface, PCIe 3.0 supports up to 8.0 GT/s (PE-5004)
- PCI Express x4 interface, PCIe 3.0 supports up to 8.0 GT/s (PE-5002)
- IEEE 802.3at Power over Ethernet (PoE⁺), up to 25.5W Power Output at 48V DC per port, with PoE⁺ On/Off Control
- IEEE 1588 Precision Time Protocol (PTP) and IEEE 802.1AS Precision Timing Synchronization compliant
- Up to 9.7KB Jumbo Frame, Link Aggregation (PE-5004)
- Up to 15.5KB Jumbo Frame, Link Aggregation (PE-5002)
- Supports IEEE 802.3az Energy Efficient Ethernet (EEE) and DMA Coalescing Power Management Features
- -25°C to 55°C Operating Temperature (PE-5004)
- -25°C to 60°C Operating Temperature (PE-5002)

1.3 Product Specification

1.3.1 Specifications of Vecow PE-5004

Ethernet	
Interface	PCI Express x8
Controller	1 Intel® Ethernet Controller XL710
PHY	1 Intel® X557
Data Rate	10Gbps/1Gbps/100Mbps
Jumbo Frame	Up to 9728 byte
Link Aggregation (LAG)	Present
Connector	8-pin RJ45
PoE Standard	IEEE 802.3at compliant
Power Requirements	
Output	<ul style="list-style-type: none">• 4 RJ45 PoE Port• 4 LED for PoE On/Off Mode• Up to 25.5W Power Output at 48V DC per port
Power Connector	1 4-pin ATX 12V Power Connector
Environment	
Operating Temperature	-25°C to 55°C with air flow (-40°F to 131°F)
Storage Temperature	-40°C to 85°C (-40°F to 185°F)
Humidity	5% to 95% Humidity, non-condensing
Relative Humidity	95% @ 55°C
Certifications	FCC, CE, RoHS compliant
Mechanical	
Dimension	168.0mm x 111.0mm (6.61" x 4.37")

1.3.2 Specifications of Vecow PE-5002

Ethernet	
Interface	PCI Express x4
Controller	1 Intel® Ethernet Controller X550-AT2
Data Rate	10Gbps/*5Gbps/*2.5Gbps/1Gbps/100Mbps (*Linux only)
Jumbo Frame	Up to 5.5KB supported
Link Aggregation (LAG)	Present
Connector	<ul style="list-style-type: none">• 2 RJ45 PoE Port• 2 LED for PoE On/Off Mode• Up to 25.5W Power Output at 48V DC per port
Environment	
Operating Temperature	-25°C to 60°C with air flow (-40°F to 140°F)
Storage Temperature	-40°C to 85°C (-40°F to 185°F)
Certifications	FCC, CE, RoHS compliant
Mechanical	
Dimension	168.0mm x 111.0mm (6.61" x 4.37")

1.4 Mechanical Dimension

1.4.1 PE-5004

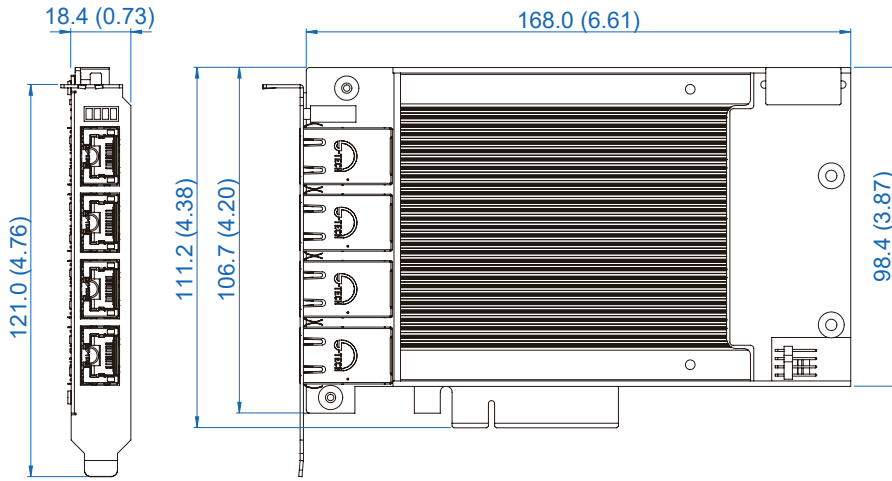

Unit : mm (inch)

1.4.2 PE-5004 With FAN

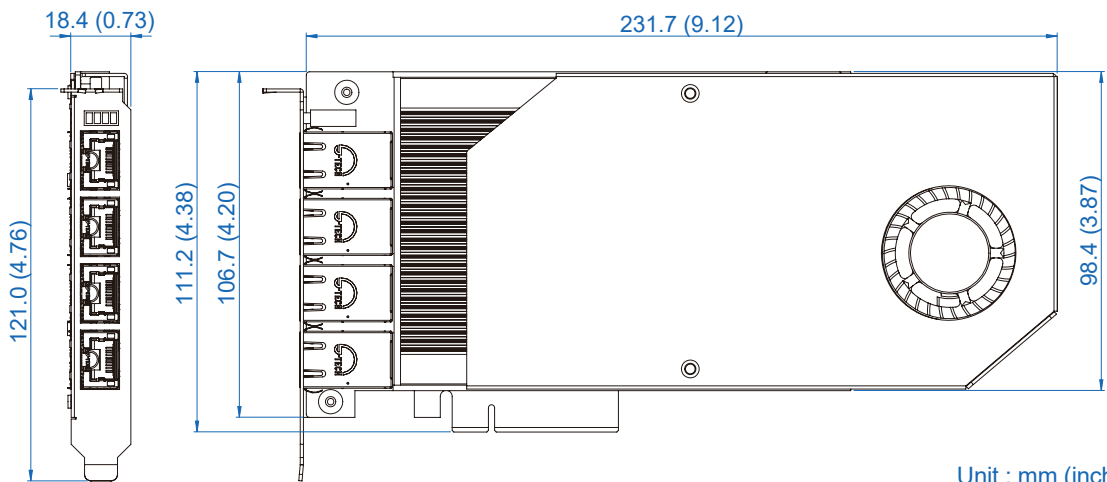

Unit : mm (inch)

1.4.3 PE-5002

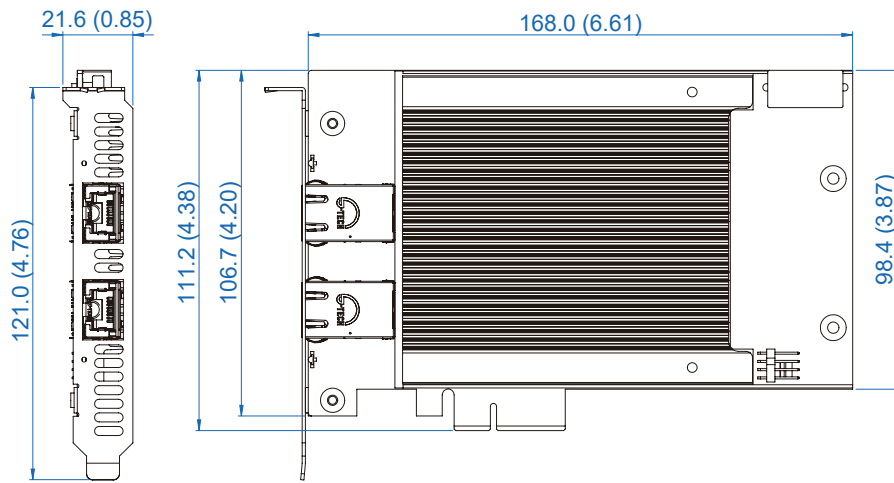

Unit : mm (inch)

1.4.4 PE-5002 With FAN

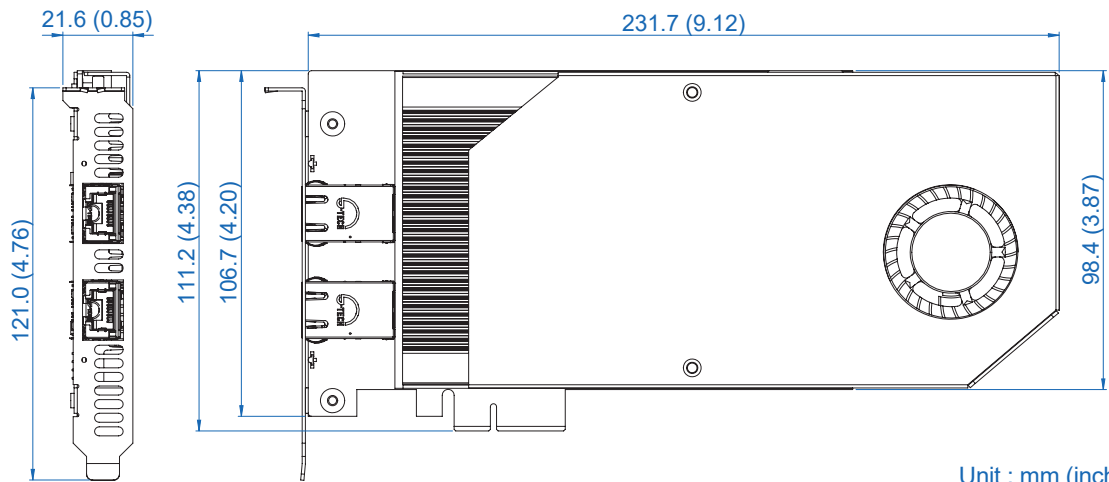

Unit : mm (inch)

2

GETTING TO KNOW YOUR PE-5000

2.1 Packing List

Item	Description	Qty
1	PE-5000, Intel® XL710 4-port/X550 2-port 10GigE PoE+ PCI Express Expansion Card (It is based on the configuration you ordered.)	1

2.2 PE-5004 I/O and Indication

2.2.1 PoE (Power over Ethernet) Ports

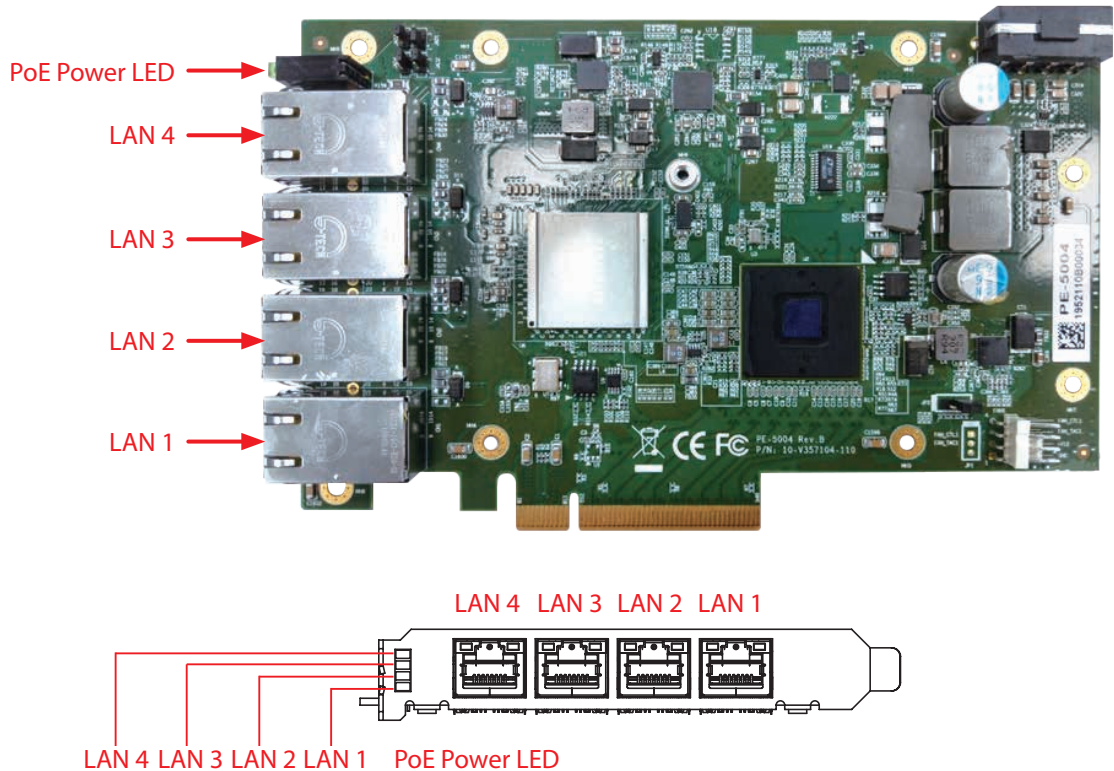

PE-5004 is equipped with 4 IEEE 802.3at PoE⁺ ports for transmitting power as much as 25.5W/48V per port and 1G/10GBASE-T gigabit data signals over standard Ethernet CAT-5/CAT-6 cable.

Each PoE connection is powered by Intel[®] XL710 10GBASE-T Gigabit Ethernet Controller and Intel[®] X557 and independent PCI express interface to connect with multi-core processor for networking and data transmit optimization. Only when PoE port starts to supply power to power devices, the dedicated LED will be lightened.

The pin-outs of LAN 1 and LAN 4 are listed as follows :

Pin No.	10/100 Mbps	1000 Mbps	PoE
1	E_TX+	MDI0_P	PoE+
2	E_TX-	MDI0_N	PoE+
3	E_RX+	MDI1_P	PoE-
4	----	MDI2_P	----
5	-----	MDI2_N	----
6	E_RX-	MDI1_N	PoE-
7	-----	MDI3_P	----
8	-----	MDI3_N	----

Each LAN port is supported by standard RJ-45 connector with LED indicators to present Active/Link/Speed status of the connection.

The LED indicator on the right bottom corner lightens in OFF when the cable is properly connected to a 100Mbps Ethernet network; The LED indicator on the right bottom corner lightens in solid orange when the cable is properly connected to a 1000Mbps Ethernet network; The left LED will keep twinkling/off when Ethernet data packets are being transmitted/received.

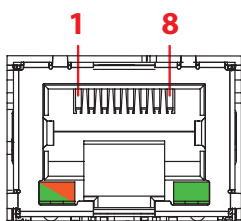

LED Status	100Mbps	1000Mbps	10Gbps
Right LED	off	Solid Orange	Solid Green
Left LED	Flash Green	Flash Green	Flash Green

PoE LED	LED Color	PoE Status
LED1-4	Solid Green	PoE On

2.2.2 Power Input

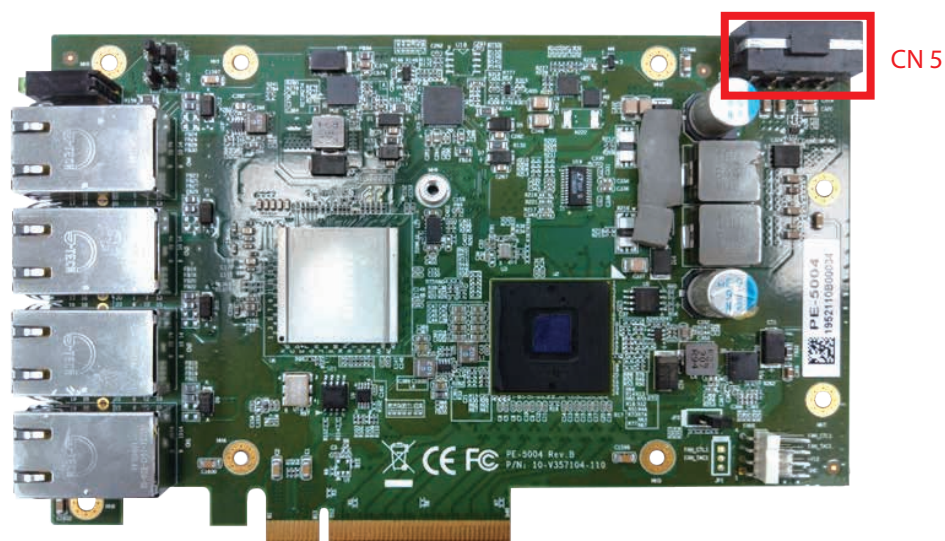

The PE-5004 is also equipped with one 4-pin power plug (12V, 6A max) for additional power supply. For most cases, the power obtained from PCIe bus is sufficient for the PoE devices, and you do not need to supply extra power to the card. In case the external power is needed, you can use 4-pin ATX power connector (+5V/Red, GND/Black, GND/Black, +12V/Yellow) inside the host computer. Please always confirm the polarity before you plug into the onboard 4-pin power plug.

CN5 :

Pin No.	Definition	Pin No.	Definition
1	NC	2	GND
3	GND	4	+12V

2.2.3 PoE Power On/Off

JAD1 - JAD4

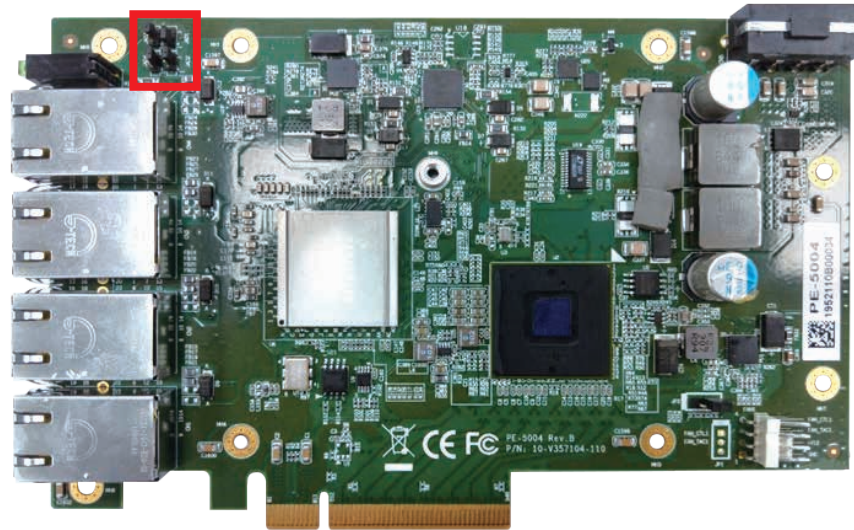

PE-5004 controls PD69104B PoE Power ON/OFF via SMBUS. Jumper JAD1~JAD14 address setting as below (1-2=H, 2-3=L) :

JAD4	JAD3	JAD2	JAD1	Address
2-3	2-3	2-3	2-3	0x40
2-3	2-3	2-3	1-2	0x42 (Default)
2-3	2-3	1-2	2-3	0x44
2-3	2-3	1-2	1-2	0x48
2-3	1-2	2-3	2-3	0x4A
2-3	1-2	2-3	1-2	0x4C
2-3	1-2	1-2	2-3	0x4E
2-3	1-2	1-2	1-2	0x50
1-2	2-3	2-3	2-3	0x52
1-2	2-3	2-3	1-2	0x54
1-2	2-3	1-2	2-3	0x56
1-2	2-3	1-2	1-2	0x58
1-2	1-2	2-3	2-3	0x5A
1-2	1-2	2-3	1-2	0x5C
1-2	1-2	1-2	2-3	0x5E

2.2.4 Fan Connector

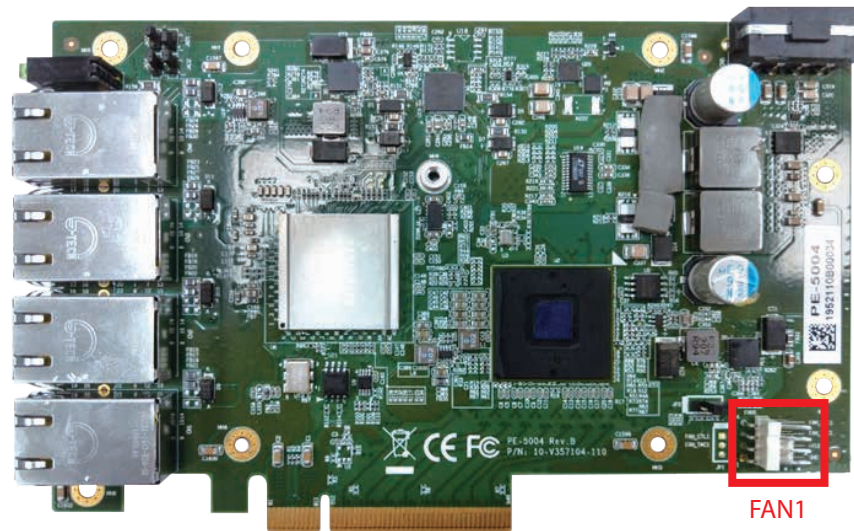

Fan power connector supports for additional thermal requirements. The pin assignments of FAN1 is listed in the following diagram :

Pin input :

	Pin No.	Definition	Pin No.	Definition
4	1	GND	2	+12V (1.5A max)
1	3	-----	4	-----

2.3 PE-5002 I/O and Indication

2.3.1 Ethernet connections

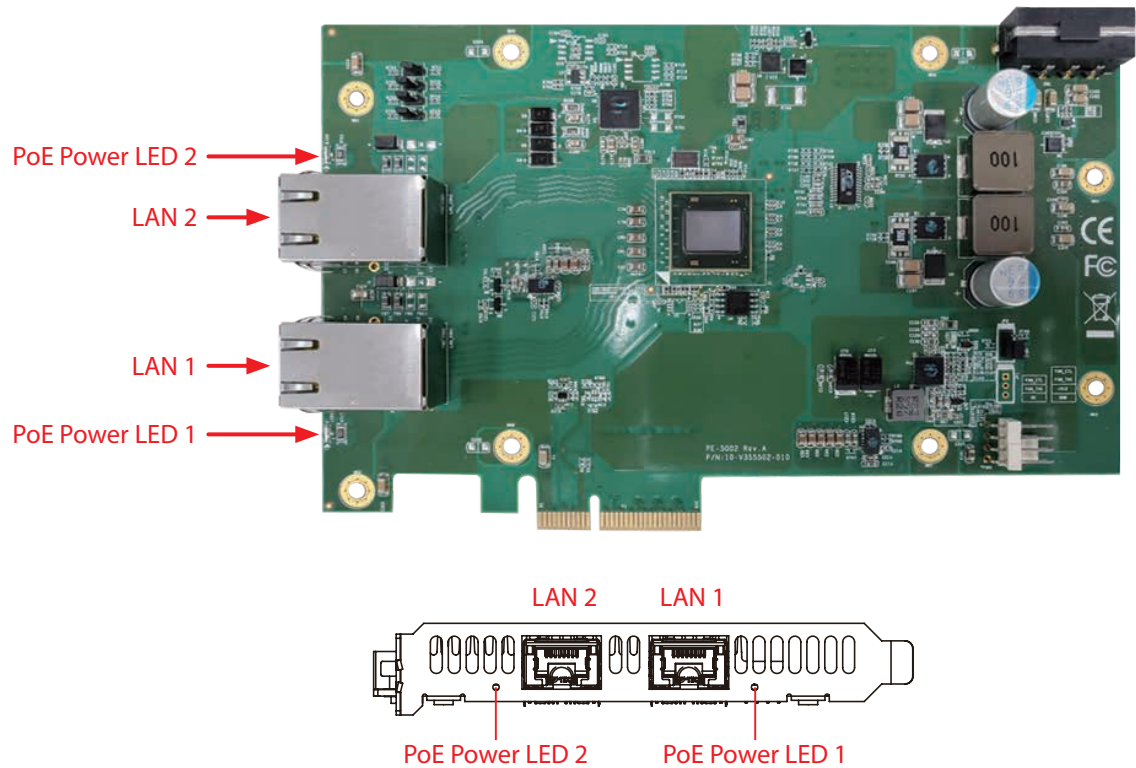

PE-5002 is equipped with 2 IEEE 802.3at PoE⁺ ports for transmitting power as much as 25.5W/48V per port and 1G/10GBASE-T gigabit data signals over standard Ethernet CAT-5/CAT-6 cable. Each PoE connection is powered by Intel® X550-AT2 10GBASE-T Gigabit Ethernet Controller and independent PCI express interface to connect with multi-core processor for networking and data transmit optimization. Only when PoE port starts to supply power to power devices, the dedicated LED will be lightened.

The pin-outs of LAN 1 and LAN 2 are listed as follows :

Pin No.	100Mbps	1/10Gbps	PoE
1	E_TX+	MDI0_P	PoE+
2	E_TX-	MDI0_N	PoE+
3	E_RX+	MDI1_P	PoE-
4	----	MDI2_P	
5	-----	MDI2_N	
6	E_RX-	MDI1_N	PoE-
7	-----	MDI3_P	
8	-----	MDI3_N	

Each LAN port is supported by standard RJ-45 connector with LED indicators to present Active/Link/Speed status of the connection.

The LED indicator on the left bottom corner lightens in solid orange when the cable is properly connected to a 1000Mbps Ethernet network; The LED indicator on the left bottom corner lightens in solid green when the cable is properly connected to a 10Gbps Ethernet network; The left LED will keep twinkling/off when Ethernet data packets are being transmitted/received. PoE port starts to supply power to power devices, the dedicated LED will be lightened.

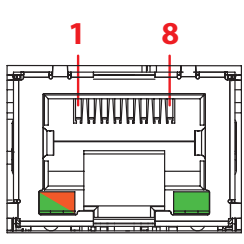

LED Status	100Mbps	1000Mbps	10Gbps
Right LED	off	Solid Orange	Solid Green
Left LED	Flash Green	Flash Green	Flash Green

PoE LED	LED Color	PoE Status
LED1-4	Solid Green	PoE On

2.3.2 Power Input

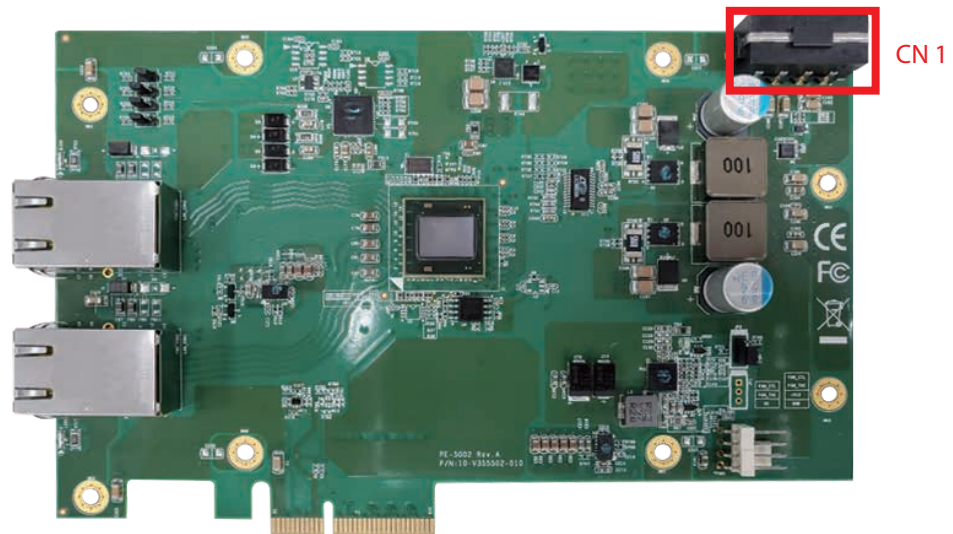

The PE-5002 is also equipped with one 4-pin power plug (12V,6A max) for additional power supply. For most cases, the power obtained from PCIe bus is sufficient for the PoE devices, and you do not need to supply extra power to the card. In case the external power is needed, you can use 4-pin ATX power connector (+5V/Red, GND/Black, GND/Black, +12V/Yellow) inside the host computer. Please always confirm the polarity before you plug into the onboard 4-pin power plug.

CN1 :

Pin No.	Definition	Pin No.	Definition
1	NC	2	GND
3	GND	4	+12V

2.3.3 PoE Power On/Off

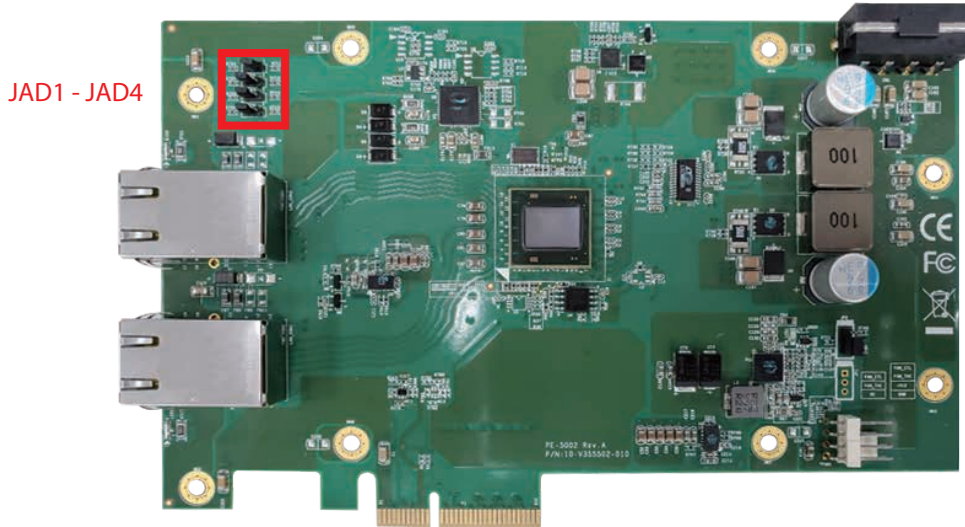

PE-5002 controls PD69104B PoE Power ON/OFF via SMBUS. Jumper JAD1~JAD14 Address setting as below (1-2=H, 2-3=L):

	JAD4	JAD3	JAD2	JAD1	Address
	2-3	2-3	2-3	2-3	0x40
	2-3	2-3	2-3	1-2	0x42 (Default)
	2-3	2-3	1-2	2-3	0x44
	2-3	2-3	1-2	1-2	0x48
	2-3	1-2	2-3	2-3	0x4A
	2-3	1-2	2-3	1-2	0x4C
	2-3	1-2	1-2	2-3	0x4E
	2-3	1-2	1-2	1-2	0x50
	1-2	2-3	2-3	2-3	0x52
	1-2	2-3	2-3	1-2	0x54
	1-2	2-3	1-2	2-3	0x56
	1-2	2-3	1-2	1-2	0x58
	1-2	1-2	2-3	2-3	0x5A
	1-2	1-2	2-3	1-2	0x5C
	1-2	1-2	1-2	2-3	0x5E

JAD1

JAD2

JAD3

JAD4

2.3.4 Fan Connector

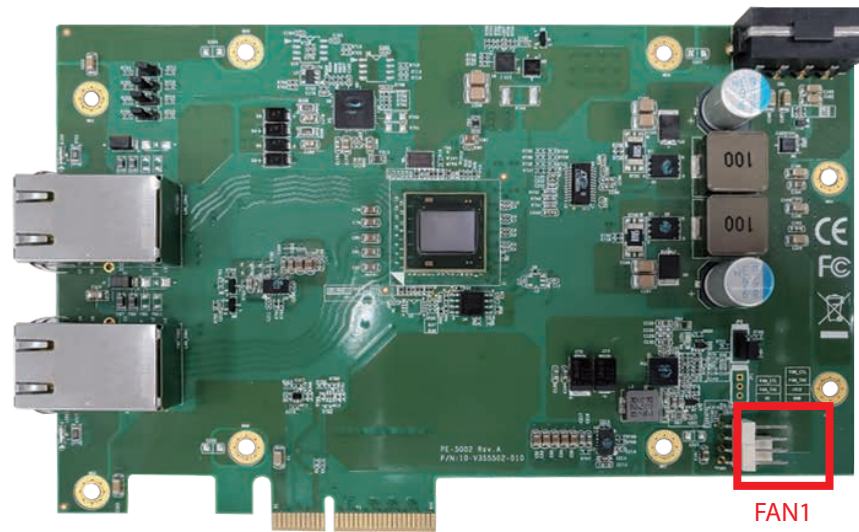

Fan power connector supports for additional thermal requirements. The pin assignments of FAN1 is listed in the following diagram :

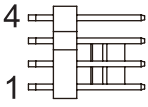
	Pin No.	Definition	Pin No.	Definition
	1	GND	2	+12V (1.5A max)
	3	-----	4	-----

3

GETTING START

3.1 Installing PE-5004/PE-5002

Step 1. Insert PE-5000 golden finger and PCI bracket into PCIe socket carefully.

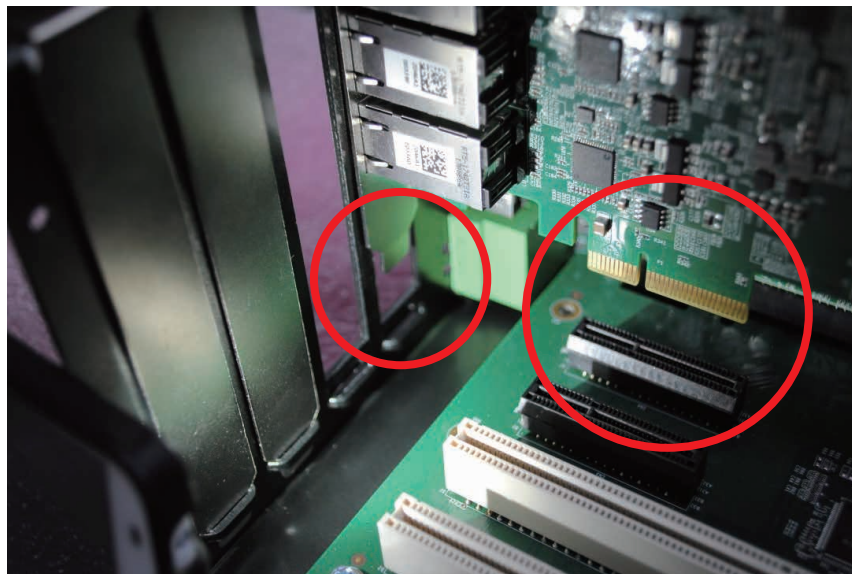

Step 2. Make sure golden finger and PCI bracket are inserted smoothly.

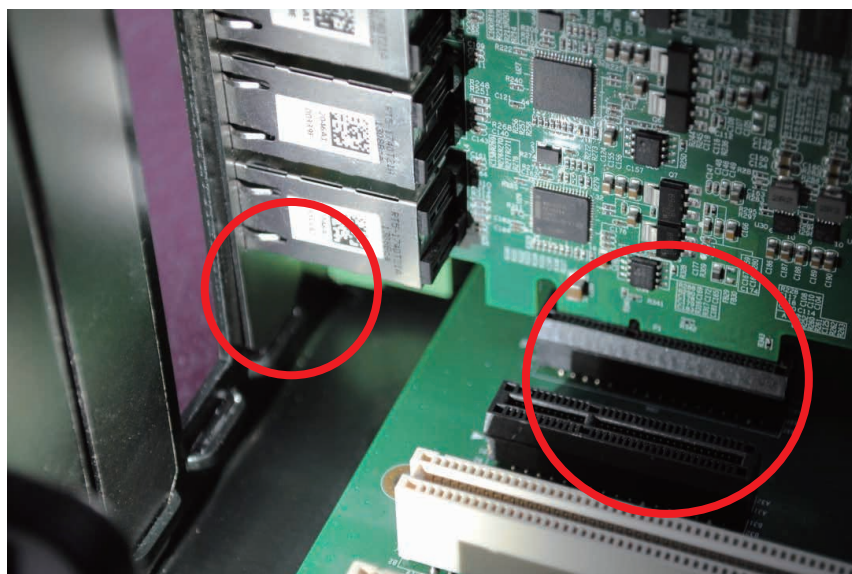

Step 3. Make sure the bracket aligns screw hole.

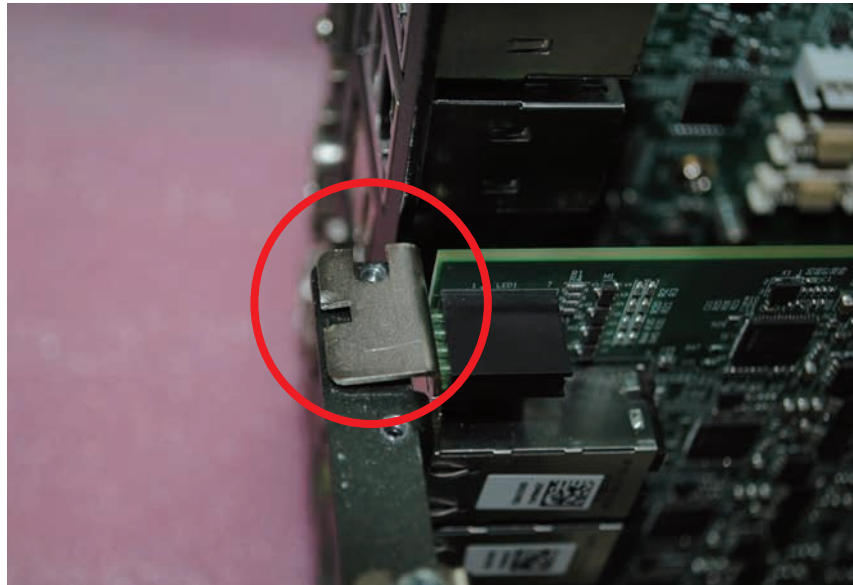

Step 4. Fasten the M3 or #6-32 screw.

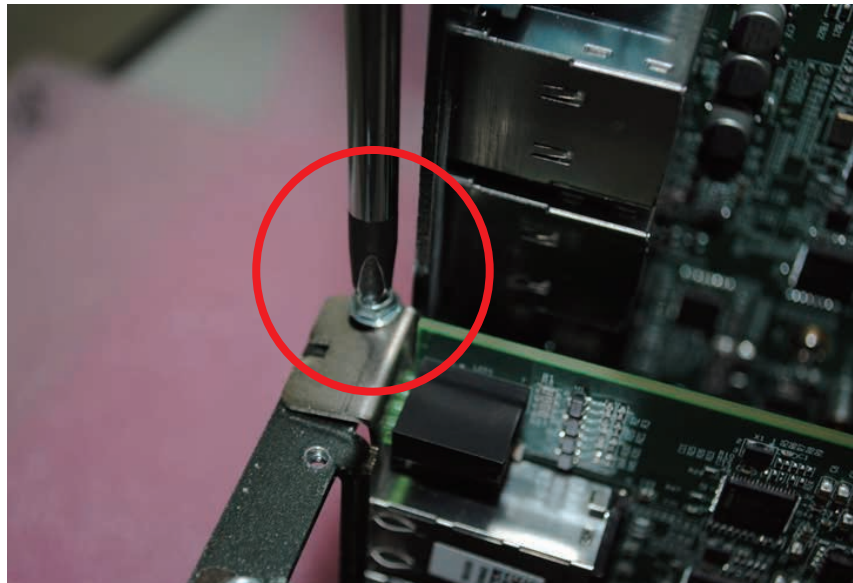

4

DRIVER INSTALLATION AND SETTING

4.1 Driver Installation

4.1.1 PE-5002 Install Driver

This section describes :
How to install drivers for PE-5002 PoE Card.

System OS :
Windows 10-64bit

Step 1. Execute "Intel PROWin64.exe" and then go "Next" step.

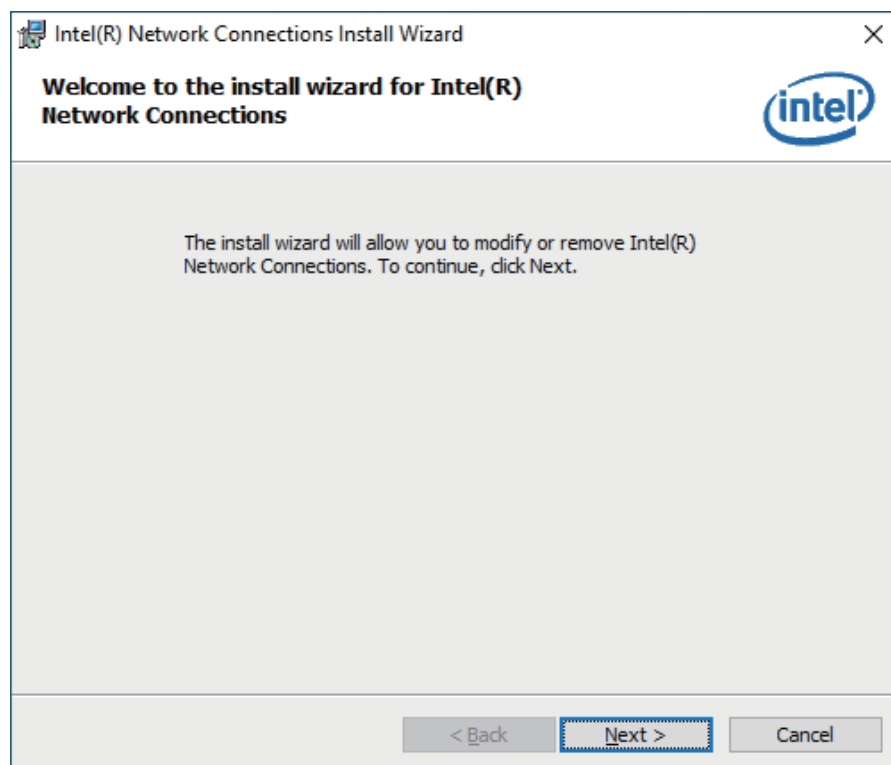

Step 2. Select "Modify" and then go to "Next" step.

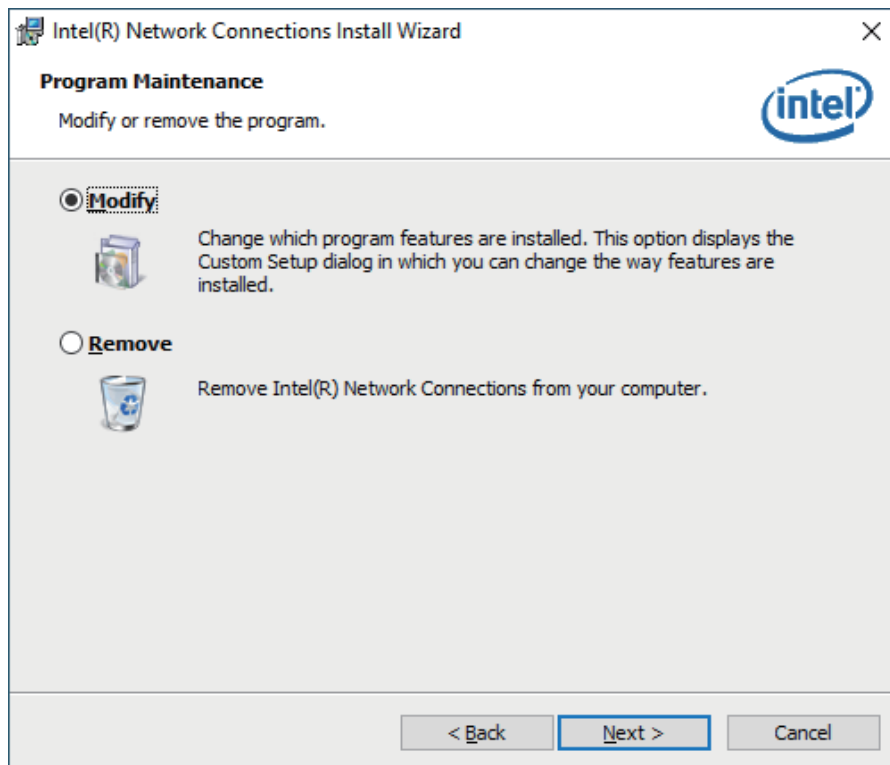

Step 3. Select "Next" step.

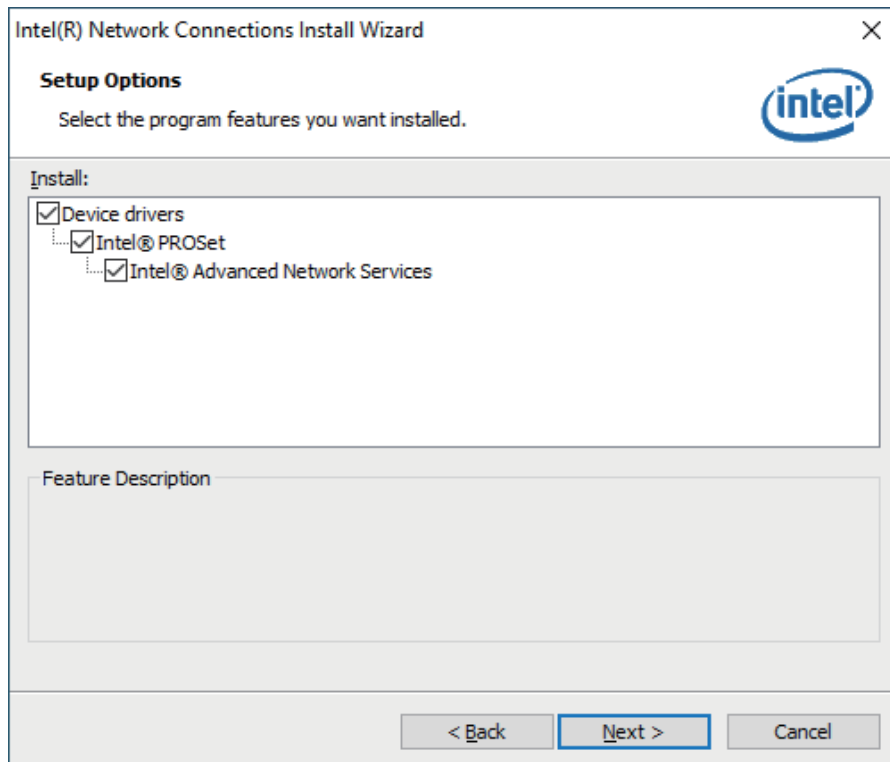

Step 4. Click the "Install" icon to begin the installation.

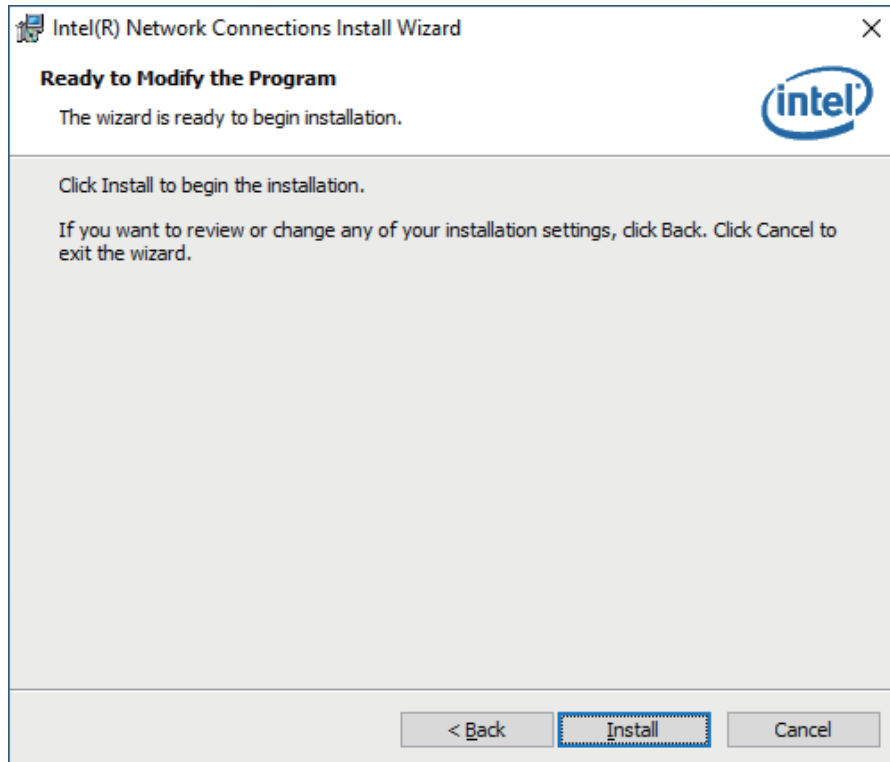

Step 5. Install wizard completed.

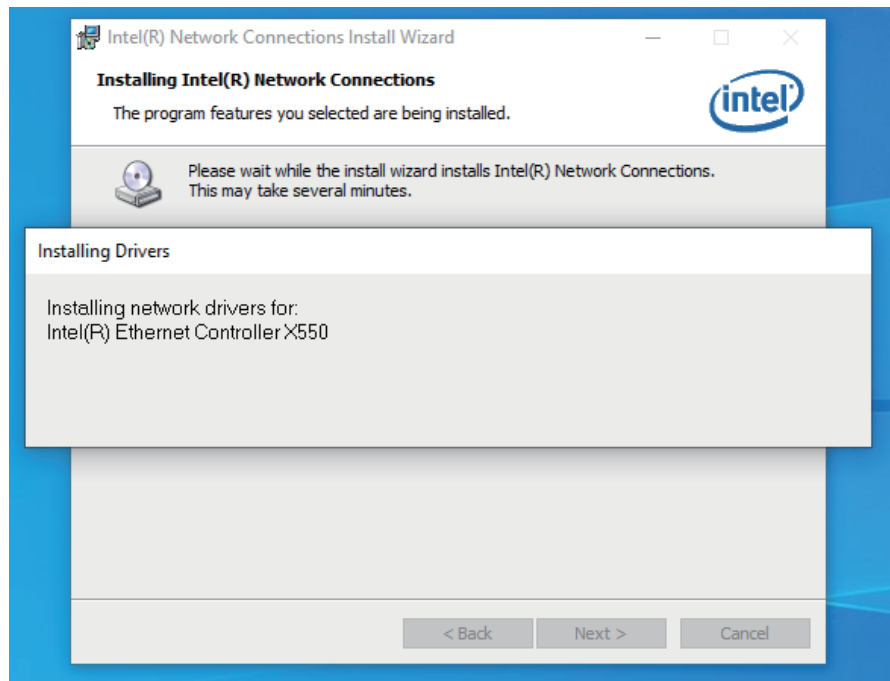

Step 6. Select "Finish" step.

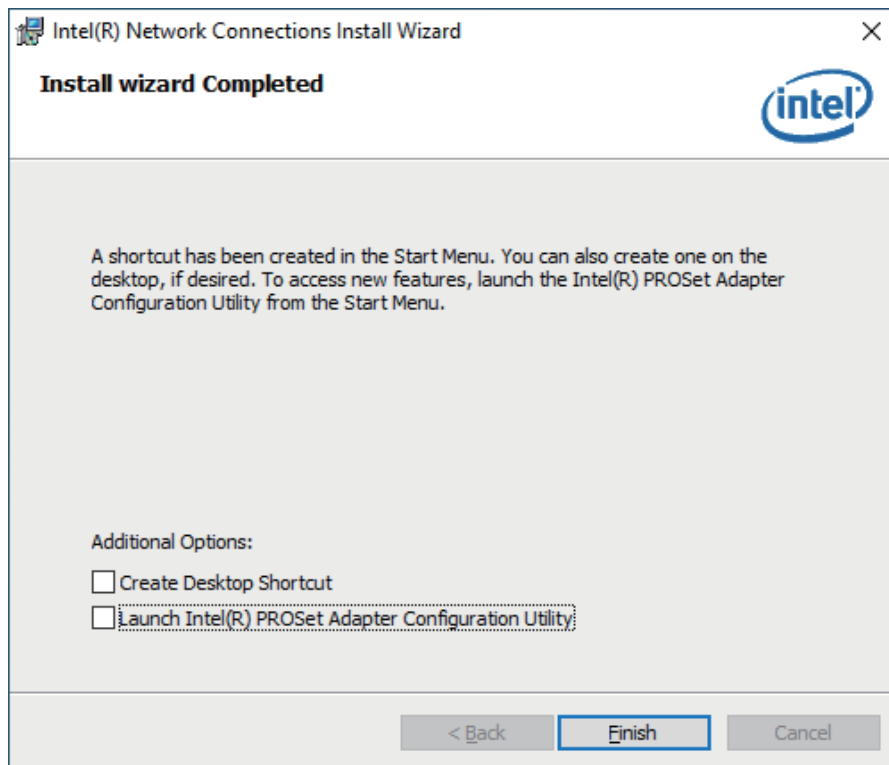

Once you need this network driver, you could remove this program on Control panel directly.

4.1.2 PE-5004 Install Driver

This section describes : How to install drivers for PE-5004 PoE Card.

System OS : Windows 10-64bit

Step 1. Install Intel_24_4 Driver and then go Open the "Right-click Device Manager → Ethernet Controller".

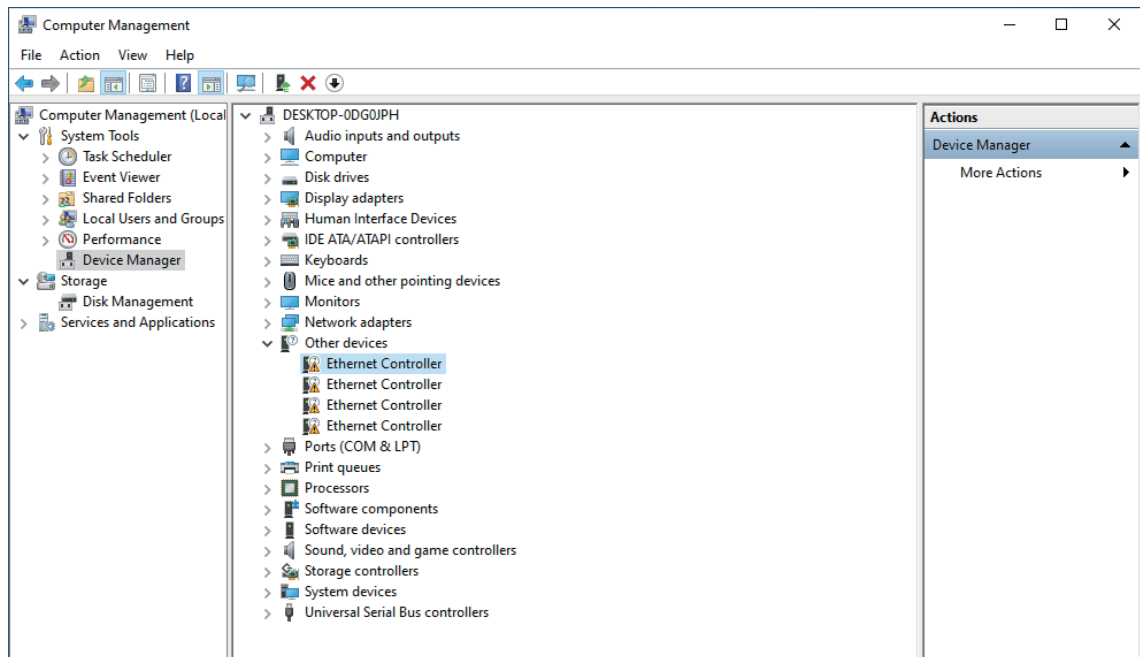

Step 2. "Right-click  Ethernet Controller → Update driver".

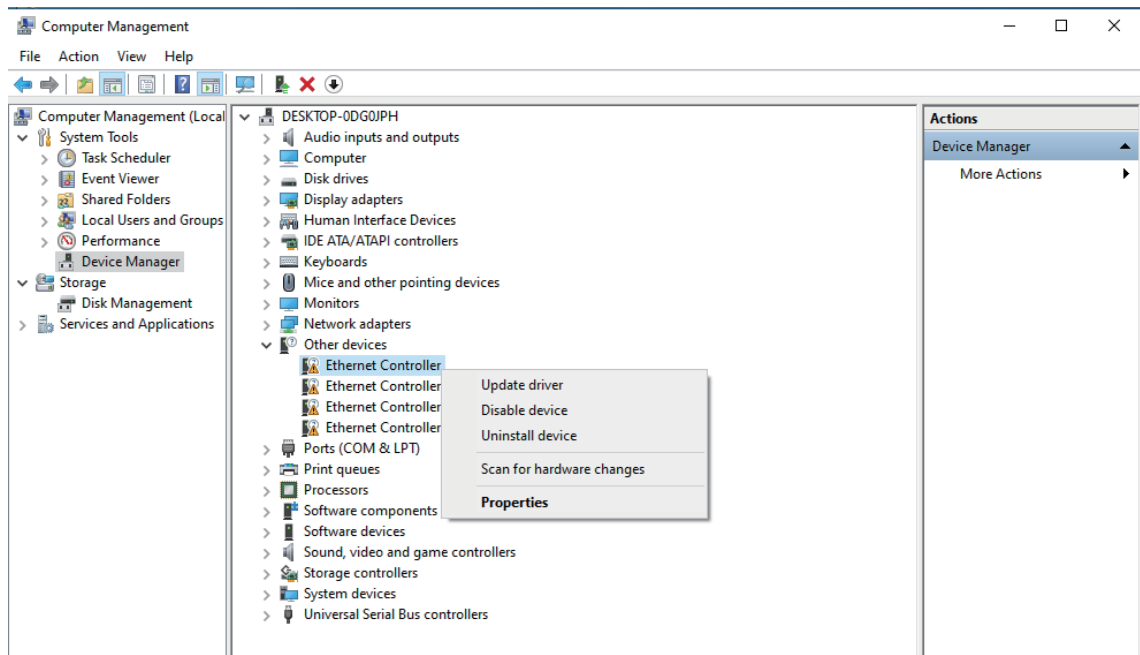

Step 3. Select the "Browse my computer for driver software".

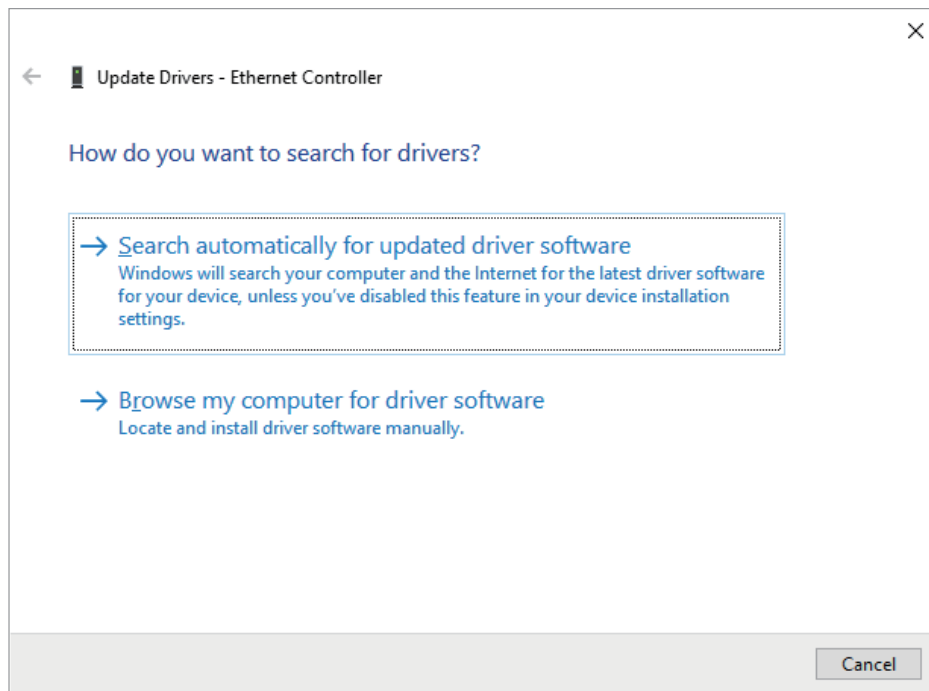

Step 4. Browse "24_4 Driver" → Next".

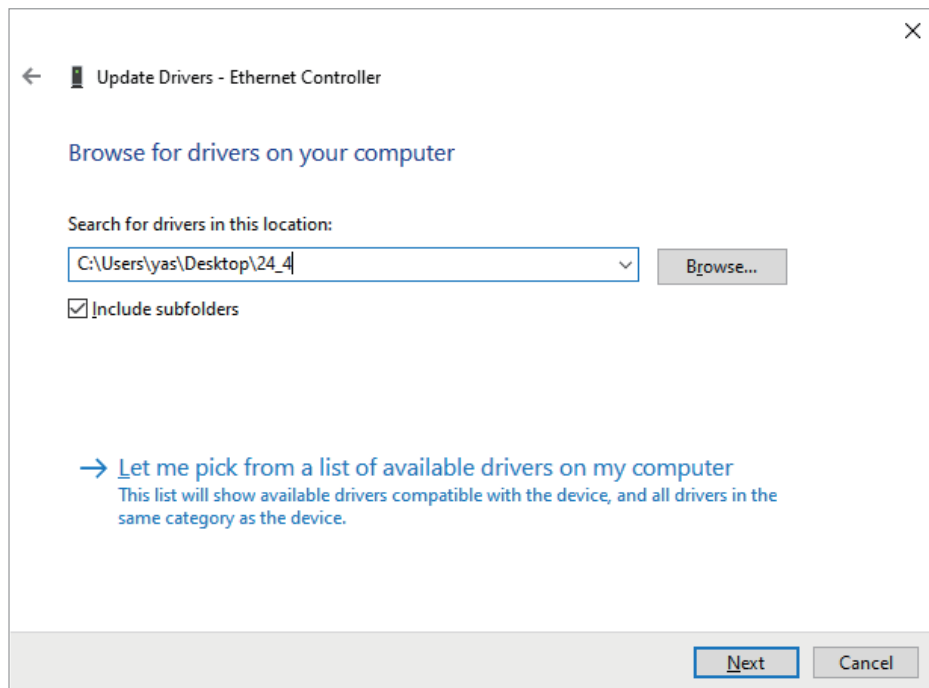

Step 5. Detect in one "Intel Ethernet Converged Network Adapter X710-T".

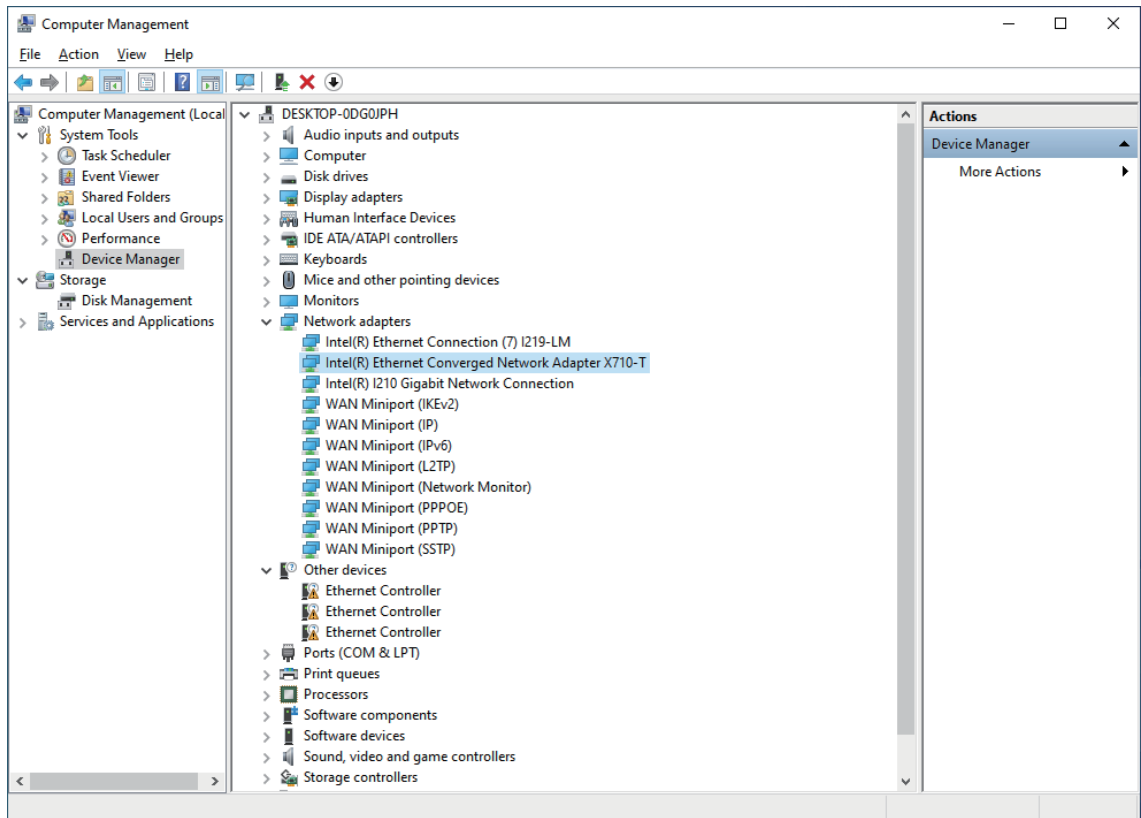

Step 6. Right-click  → Restart.

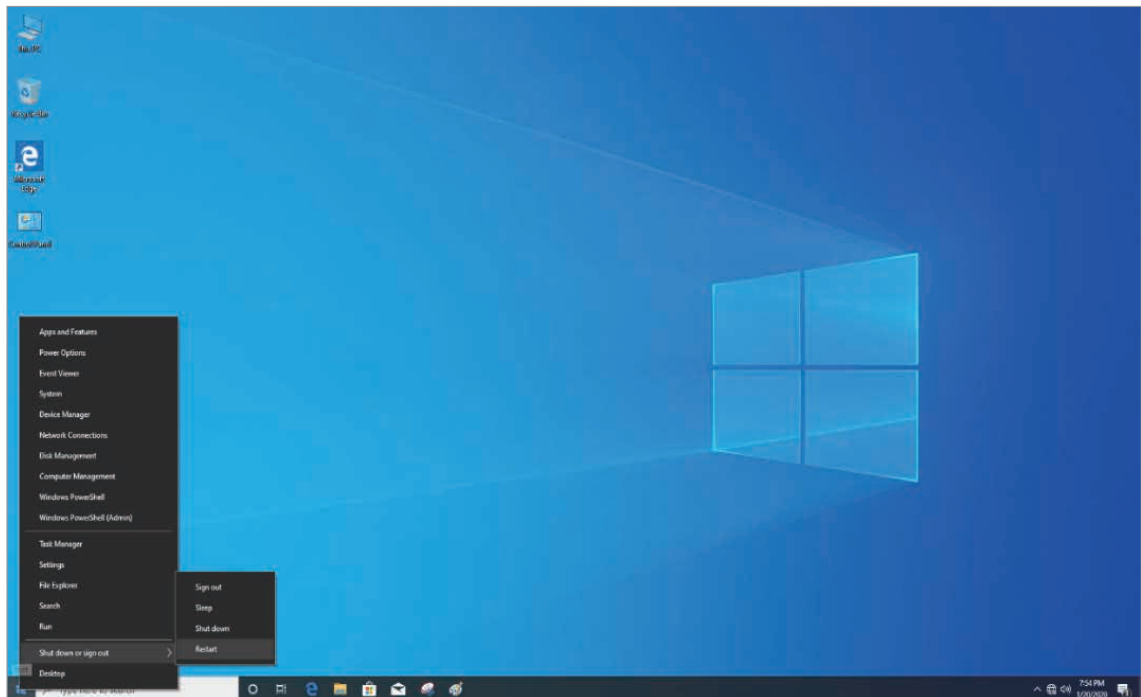

Step 7. Detect in "four Intel Ethernet Converged Network Adapter X710-T#xx".

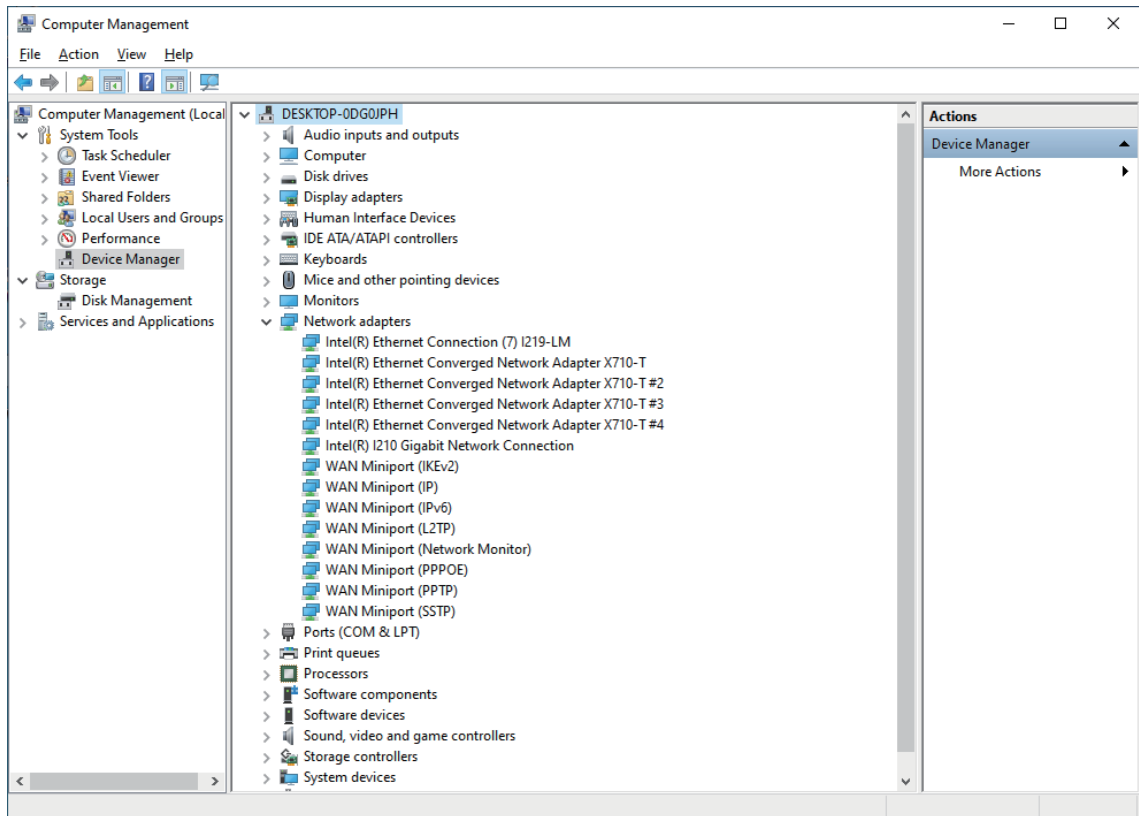

4.2 Jumbo Frame

4.2.1 PE-5002 Jumbo Frame

After installing the driver for Intel® X550 controller, you can get the enhance function that called jumbo frame, please find more instruction as below.

Step 1. "Right-click  → Device Manager → Network adapters".

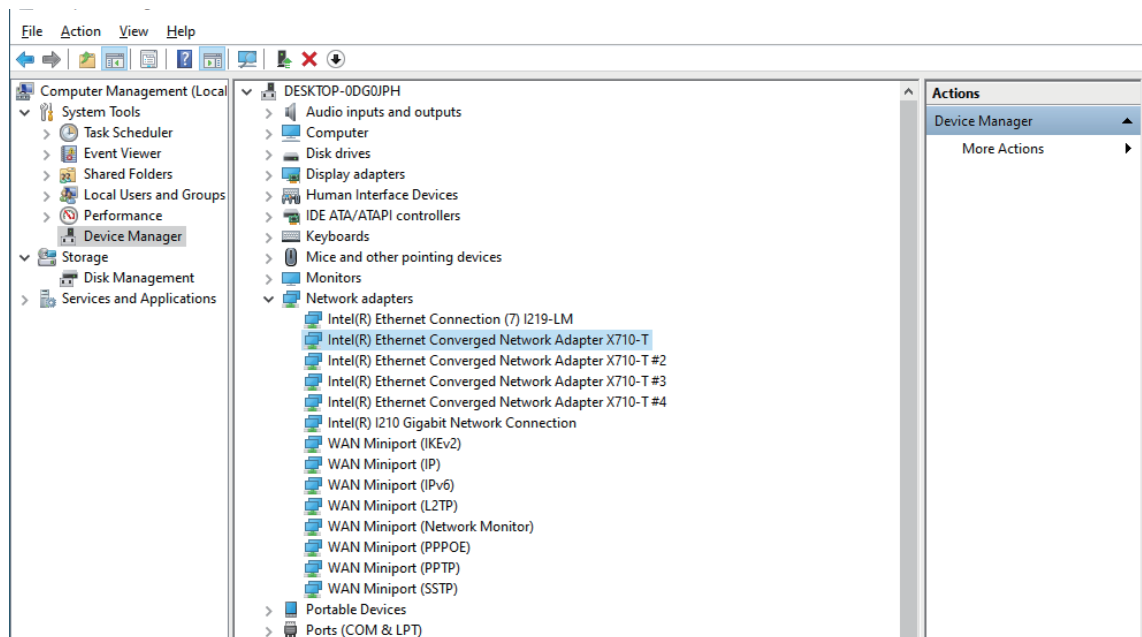

Step 2. Select anyone "Intel® Network Connection X550 #xx", right Click and select "Properties", a property dialog appears and Click on the Advanced page.

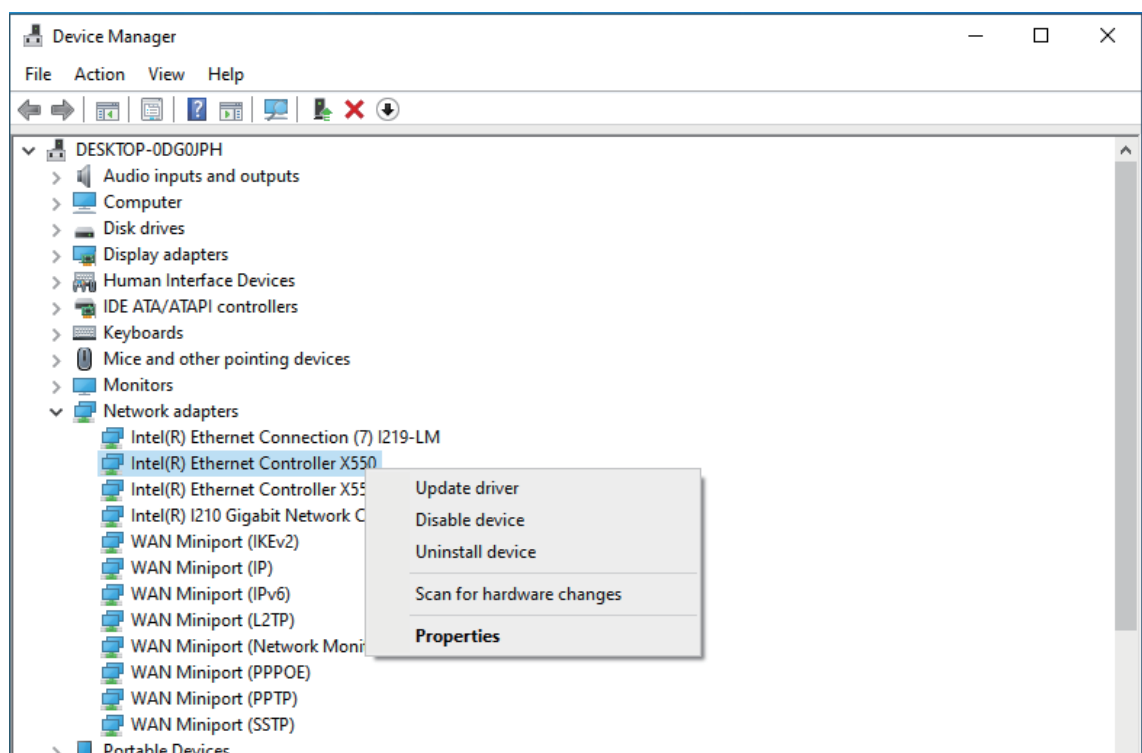

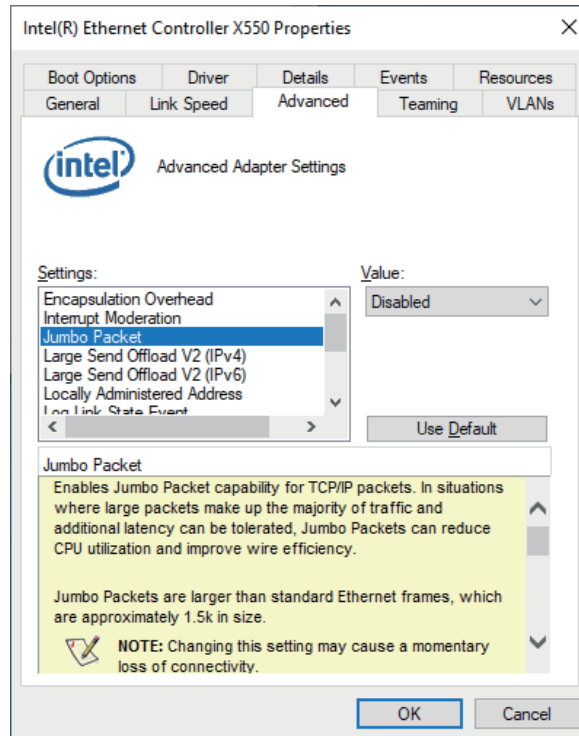

Step 3. Select the "Jumbo Packet", settings, and select the expected jumbo frame size.

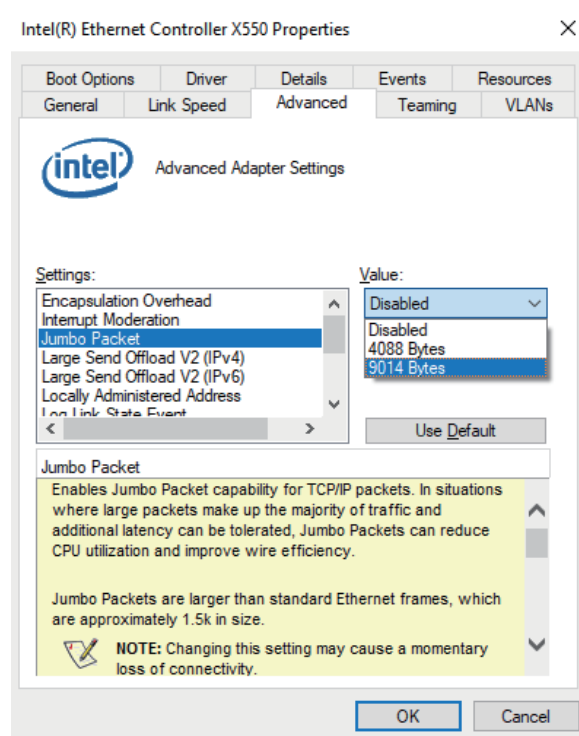

4.2.2 PE-5004 Jumbo Frame

After installing the driver for Intel® X710-T controller, you can get the enhance function that called jumbo frame, please find more instruction as below.

Step 1. "Right-click  → Device Manager → Network adapters".

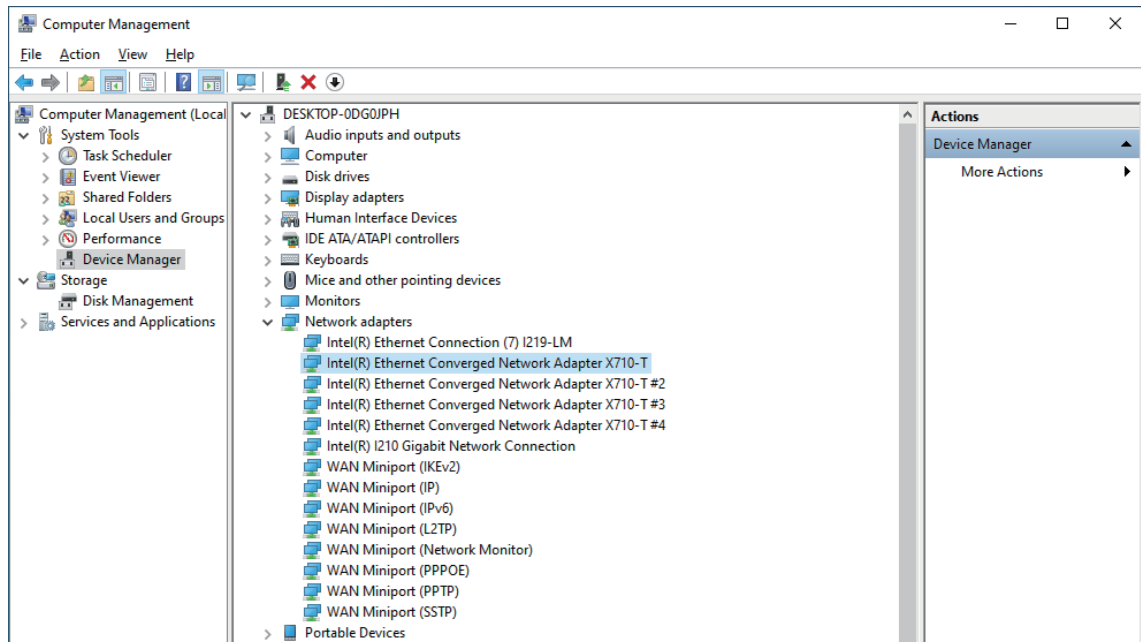

Step 2. Select anyone "Intel Ethernet Converged Network Adapter X710-T #xx", right Click and select "Properties", a property dialog appears and Click on the Advanced page.

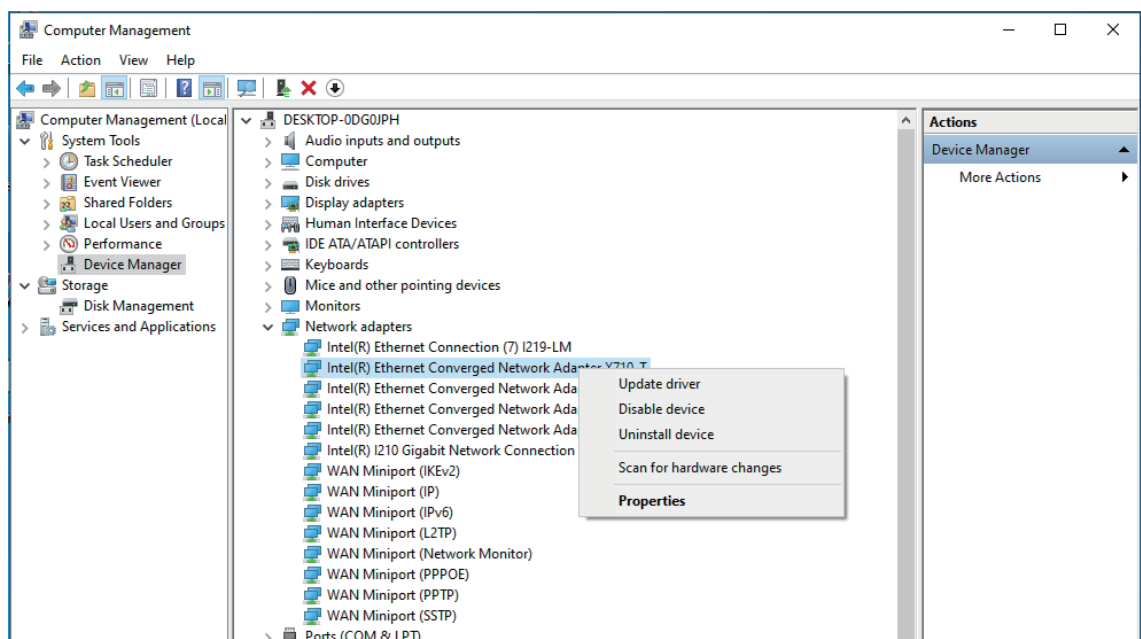

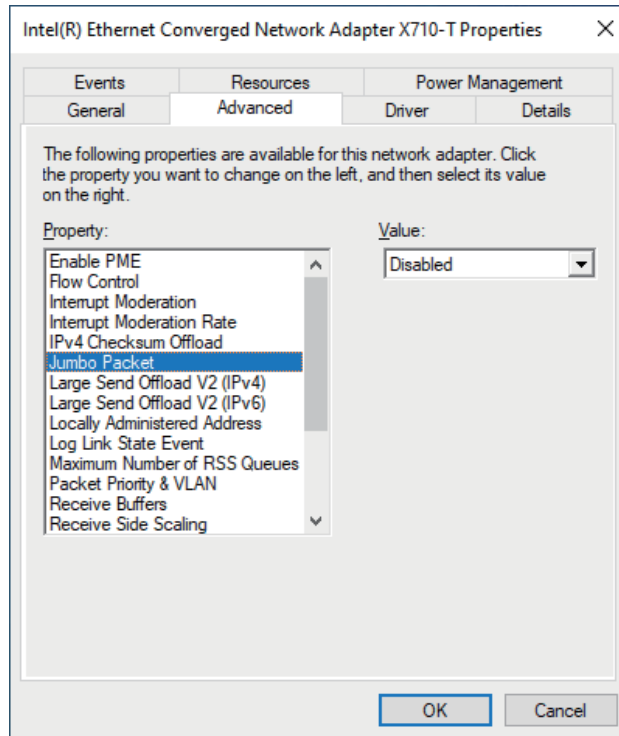

Step 3. Select the "Jumbo Packet", settings, and select the expected jumbo frame size.

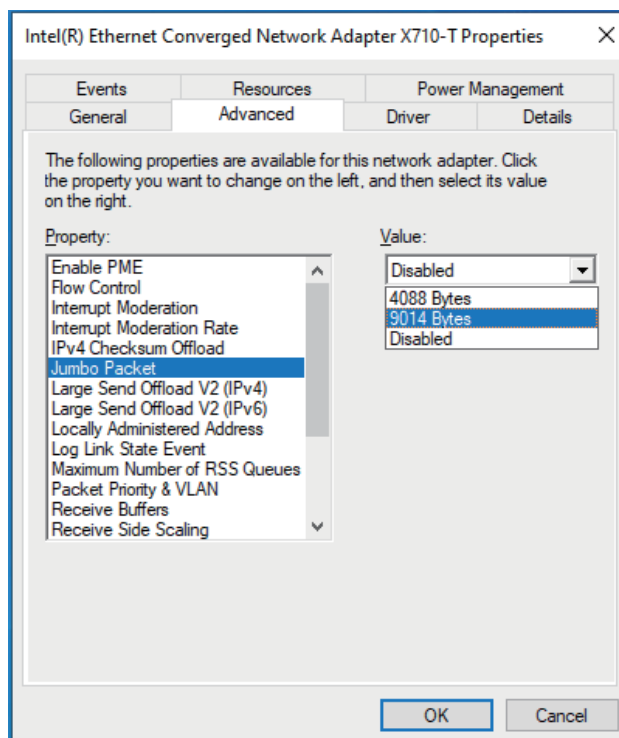

4.3 Link Aggregation

4.3.1 PE-5002 Jumbo Frame

Step 1. Here shows another enhance network function "Teaming".

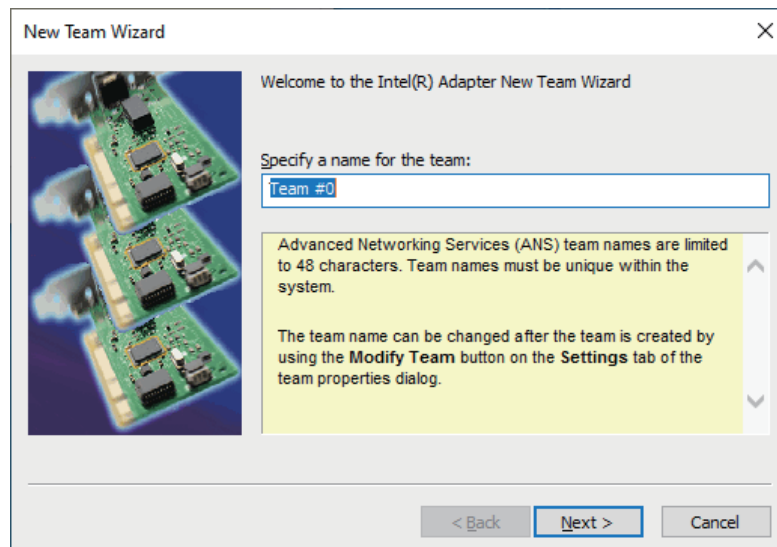
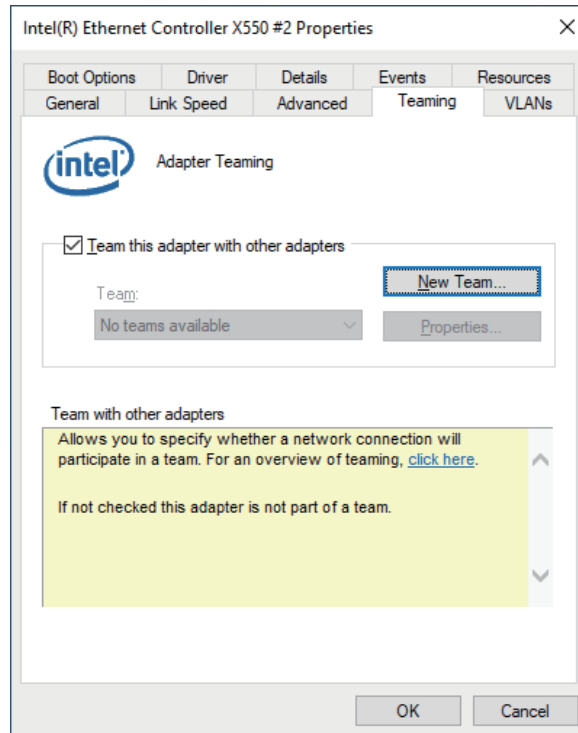

Step 2. You could multi-select network device to get a high performance net.

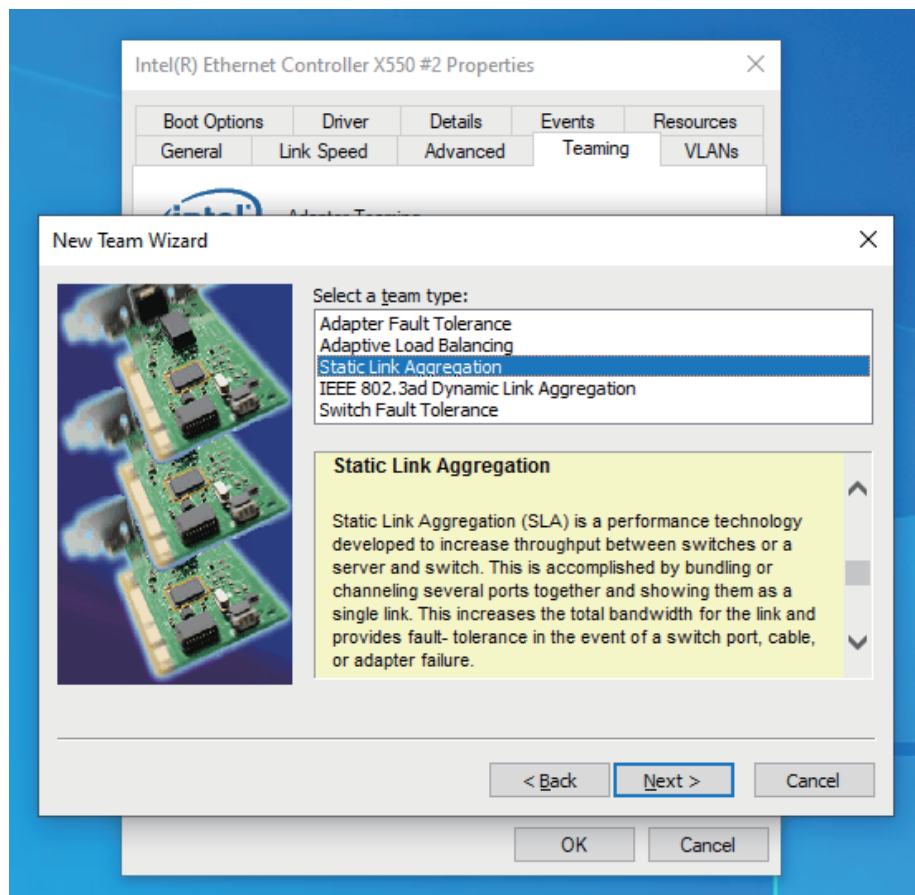
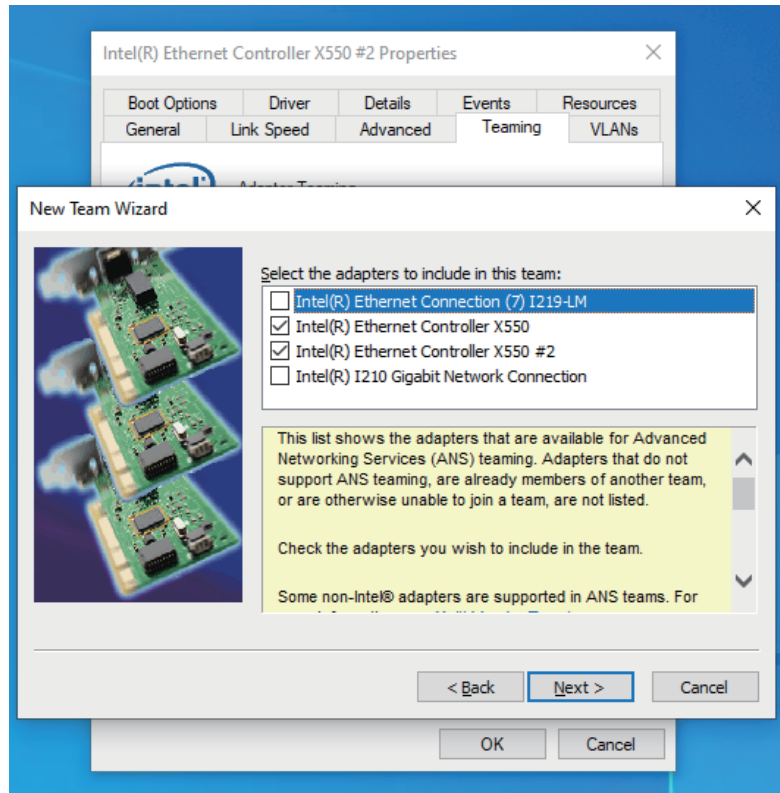

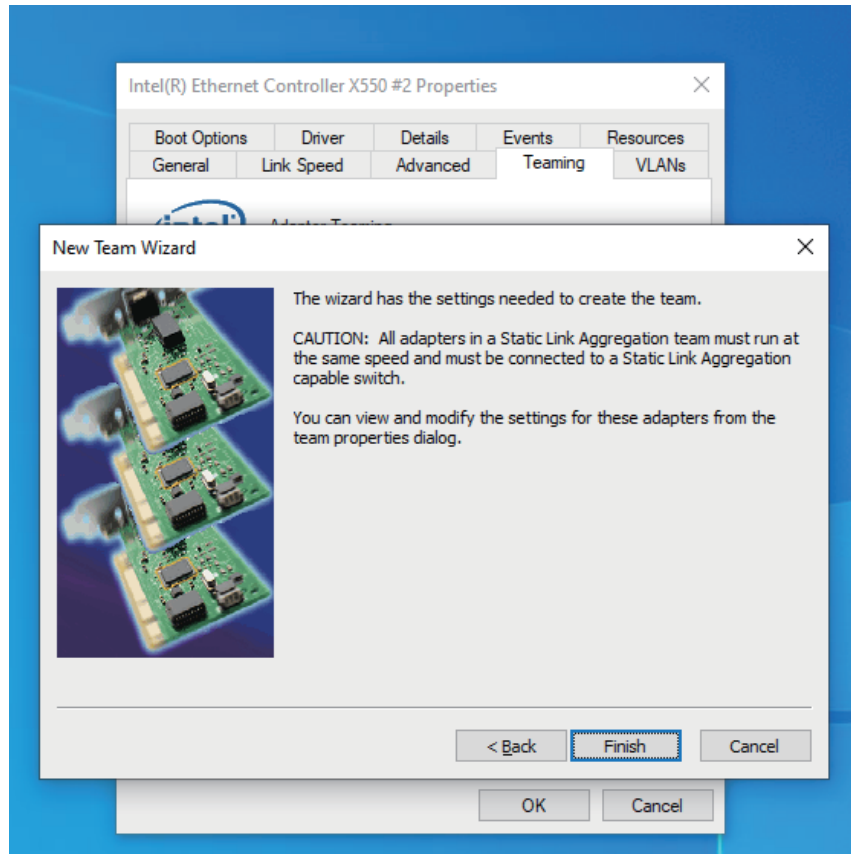

4.3.2 PE-5004 Jumbo Frame

Step 1. Here shows another enhance network function "Teaming".

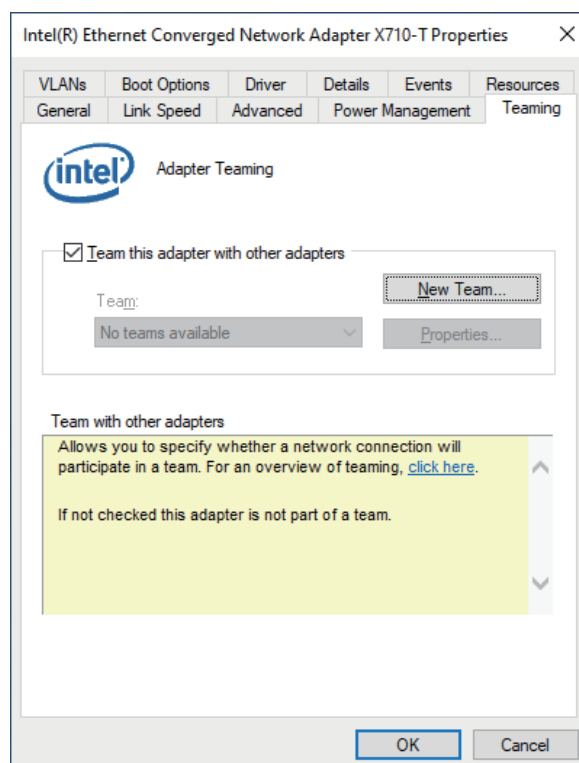

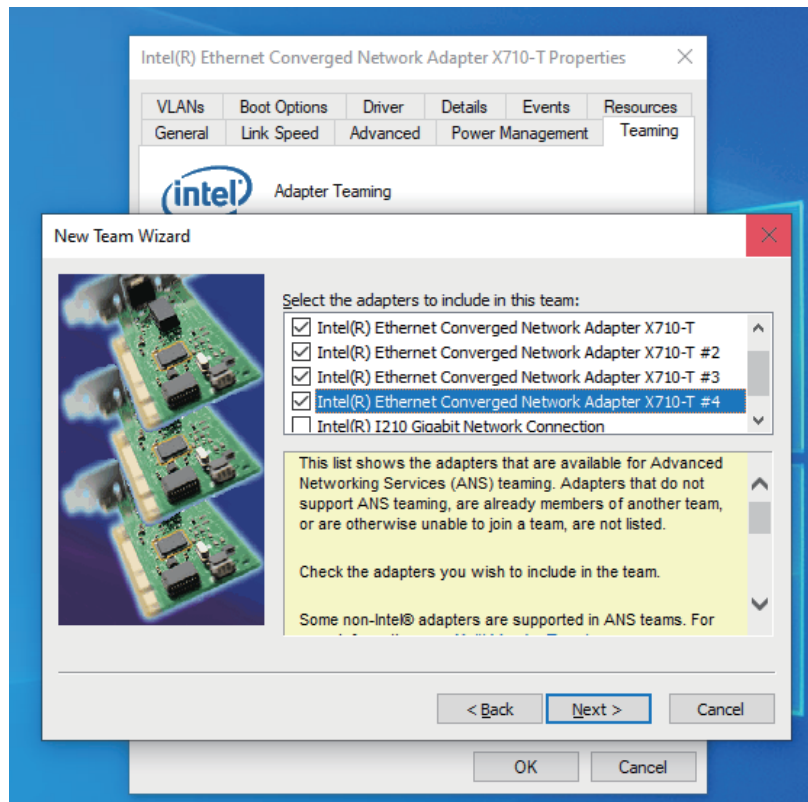
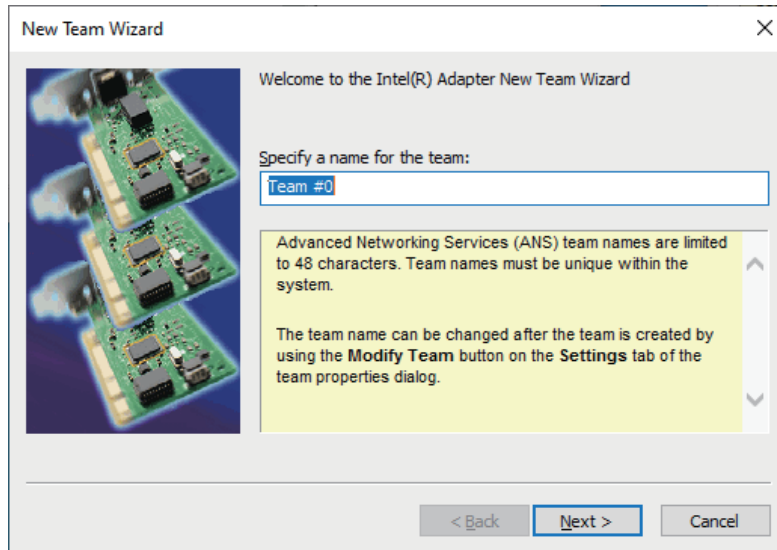

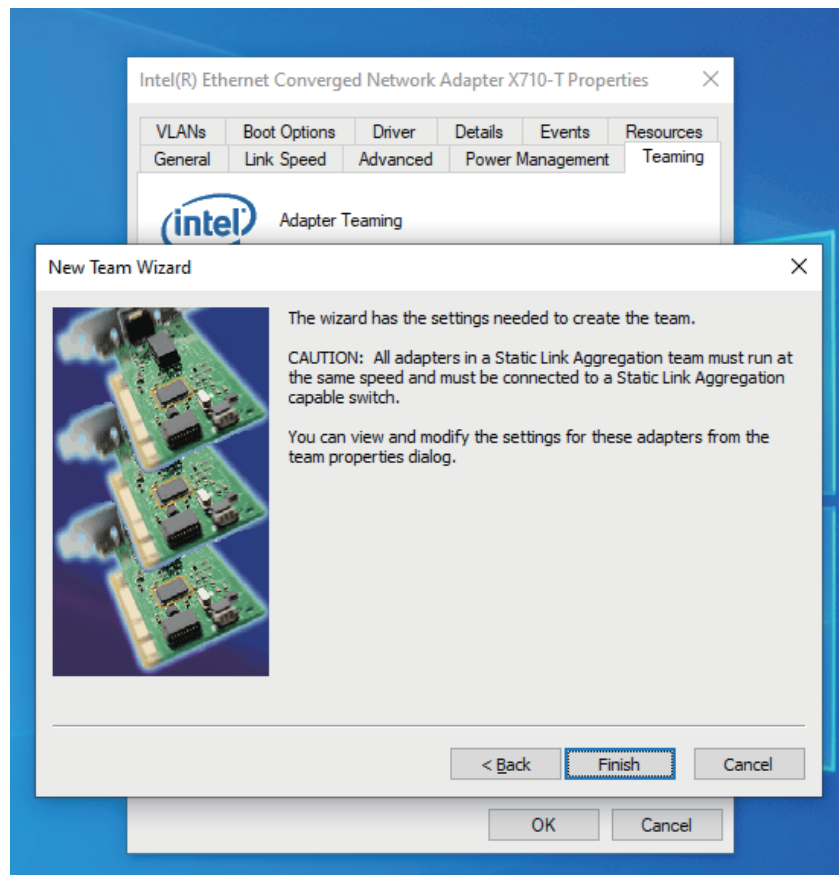
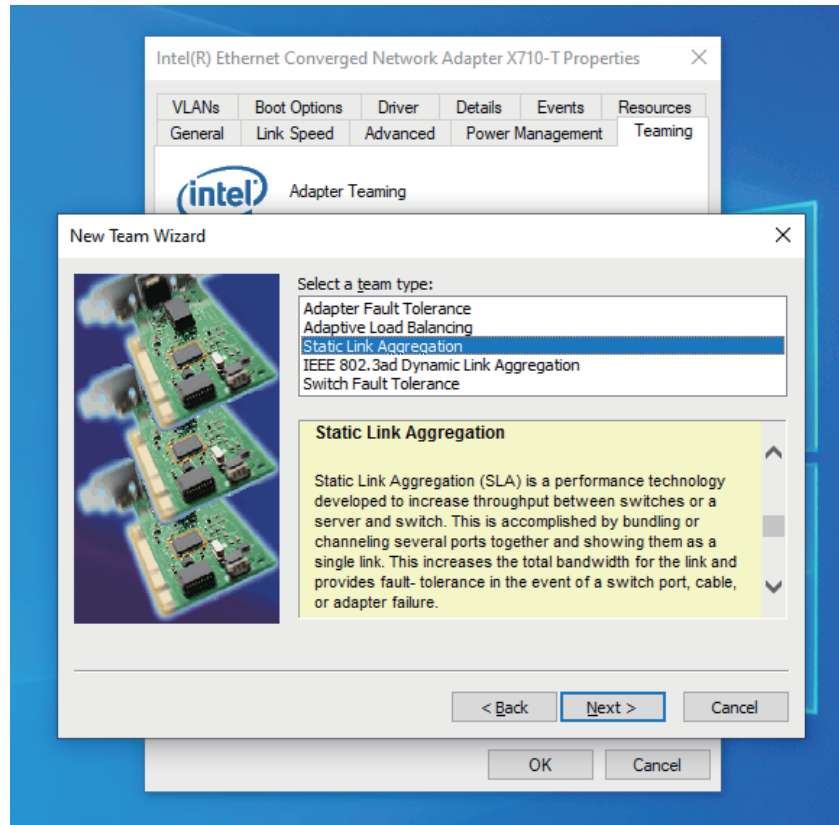

A

APPENDIX A : PoE Guide

A.1 Function Description

The PE-5000 series offers a 2-port/4-port PoE.

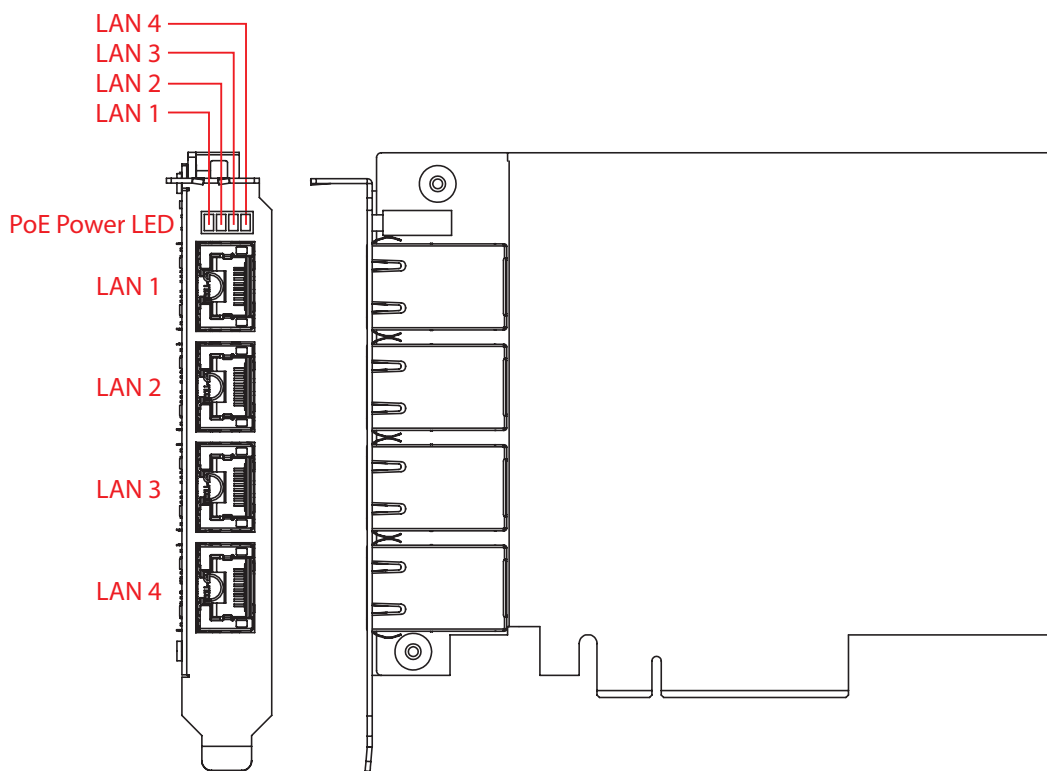

Pin No.	Definition	Pin No.	Definition
LAN 1	POE 0	LAN 3	POE 2
LAN 2	POE 1	LAN 4	POE 3

Do NOT use these functions in below :

1. ECS-4000: DIO1 (ID = 2), POE (ID = 0)
2. ECS-4500, ECS-9000, ECS-9200, ECS-9700, IVH-7700, IVH-9000, IVH-9200: POE (ID = 0)
3. RCS-7000: GPIO (ID = 0)
4. PE-2000: DIO1 (ID is the same, ID = 0 ~ 7), POE (ID = 0)
5. UE-1000: USB (IDUE-1000 = IDPE-3000 >> 1 & 3 | IDPE-3000 << 2 & 4)

PoE ON/OFF vs Slave address setting as below :

PE-5004 controls PD69104B PoE Power ON/OFF via SMBUS. Jumper JAD1~JAD14 address setting as below (1-2=H, 2-3=L):

JAD4	JAD3	JAD2	JAD1	Address
2-3	2-3	2-3	2-3	0x40
2-3	2-3	2-3	1-2	0x42 (Default)
2-3	2-3	1-2	2-3	0x44
2-3	2-3	1-2	1-2	0x48
2-3	1-2	2-3	2-3	0x4A
2-3	1-2	2-3	1-2	0x4C
2-3	1-2	1-2	2-3	0x4E
2-3	1-2	1-2	1-2	0x50
1-2	2-3	2-3	2-3	0x52
1-2	2-3	2-3	1-2	0x54
1-2	2-3	1-2	2-3	0x56
1-2	2-3	1-2	1-2	0x58
1-2	1-2	2-3	2-3	0x5A
1-2	1-2	2-3	1-2	0x5C
1-2	1-2	1-2	2-3	0x5E

A.2 Software Package Contain

Distribution folder include x32 and x64 versions, use batch file for installation.

There are included as followed :

Win7_32.bat :

Installation for 32-bit driver

Win7_64.bat :

Windows update package which driver required (need to restart), and Installation for 64-bit driver

Win8_32.bat, Win8_64.bat :

Installation for driver, and guideline to Framework 3.5 distribution for sample

Win10_32.bat, and Win10_64.bat :

Installation for driver, and installation to Framework 3.5 distribution for sample

Uninstall_32.bat, and Uninstall_64.bat :

Uninstallation for driver

Run batch file as Administrator.

Support Windows 7 above.

Make sure it is Windows version before installation.

Runtime folder includes head file for software developer or System Integration.

Sample folder includes sample program, driver library, and API library. Source

folder includes sample program source code that compile on Visual Studio 2008.

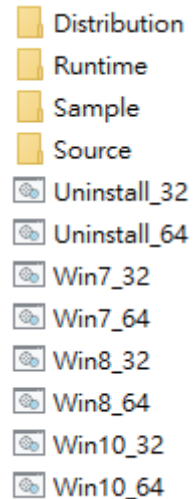

A.3 Sample

Sample folder include x32 and x64 versions, as shown below :

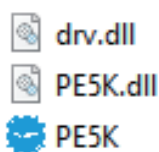

Sample PE5K.exe, as shown below :

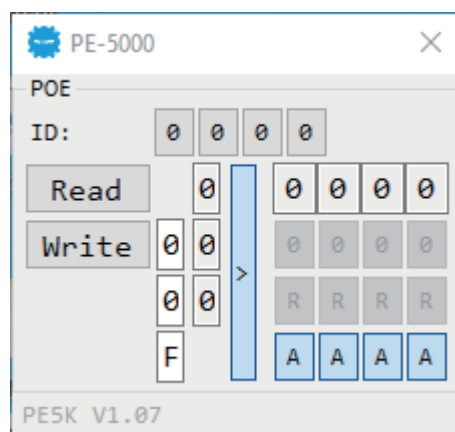

POE group :

Read button :

Set POE configuration to get POE state.

Write button :

Set POE configuration to set POE state.

POE output text :

User setting, POE output state by hexadecimal bitmask - on/off.

Use for Write button activate.

POE writable text :

User setting, POE writable of POE configuration by hexadecimal bitmask - yes/no.

Use for Write button activate.

POE mode text :

User setting, POE mode of POE configuration by hexadecimal bitmask - Auto/Manual.

Use for Write button activate.

POE input text (read only) :

POE input state by hexadecimal bitmask - on/off.

Use for Read button activate.

POE text (read only) :

POE output state with input state and configuration.

Use for Write button activate.

POE output text (read only) :

POE output state with configuration.

Use for Write button activate.

POE input port texts (read only, port 4 ~ port 1) :

POE input port state

Use for Read button activate.

POE output port check button(port 4 ~ port 1) :

User setting, POE output port state

Use for Write button activate.

POE port writable check button(port 4 ~ port 1) :

User setting, POE port writable of POE configuration.

Use for Write button activate.

POE port mode check button(port 4 ~ port 1) :

User setting, POE port mode of POE configuration.

Use for Write button activate.

B

APPENDIX B : Software Functions

B.1 Driver API Guide

In Runtime folder, on PE5K.h :

`_DLL_IMPORT_` definition is used on LoadLibrary API for PE5K.dll. `PE5K_EXPORTS` definition is used on PE5K.dll building.

BOOL Initial(BYTE Scan, BYTE ID)

Initial card for POE

Scan : POE ID scan type

2: Auto scan; 1: Manual setup; 0: Not detect ID ([3:0]): POE ID by manual setting

Return :

TRUE (1): Success;

FALSE (0): Fail (Driver not exists, or out of range error, or initial error (version is too old, or card not match))

BOOL GetPOEConfig(BYTE ID, BYTE *Auto, BYTE *Mask)

Get POE configuration (by variable) ID ([3:0]): POE ID

Auto ([3:0]): Auto mode, pin setting by hexadecimal bitmask

1: Auto;

0: Manual

Mask ([3:0]): DC Enable/Disable, pin setting by hexadecimal bitmask

1: Enable;

0: Disable

Return :

TRUE (1): Success;

FALSE (0): Fail (Initial error, or call by pointer error, or hardware problem)

BOOL SetPOEConfig(BYTE ID, BYTE Auto, BYTE Mask)

Set POE configuration ID ([3:0]): POE ID

Auto ([3:0]): Auto mode, pin setting by hexadecimal bitmask

1: Auto;

0: Manual

Mask ([3:0]): DC Enable/Disable, pin setting by hexadecimal bitmask

1: Enable;

0: Disable

Return :

TRUE (1): Success;

FALSE (0): Fail (Initial error, or out of range error, or hardware problem)

BOOL GetPOE(BYTE ID, BYTE *POE)

Get POE input

ID ([3:0]): POE ID

POE ([3:0]): POE state, pin setting by hexadecimal bitmask

1: On;

0: Off

Return :

TRUE (1): Success;

FALSE (0): Fail (Initial error, or call by pointer error, or hardware problem)

BOOL SetPOE(BYTE ID, BYTE POE)

Set POE output

ID ([3:0]): POE ID

POE ([3:0]): POE state, pin setting by hexadecimal bitmask

1: On;

0: Off

Return :

TRUE (1): Success;

FALSE (0): Fail (Initial error, or out of range error, or hardware problem)



For further support information, please visit www.vecow.com

This document is released for reference purpose only.

All product offerings and specifications are subject to change without prior notice.

No part of this publication may be reproduced in any form or by any means, electric, photocopying, or recording, without prior authorization from the publisher.

The rights of all the brand names, product names, and trademarks belong to their respective owners.

© Vecow Co., Ltd. 2020. All rights reserved.